

1: 9.5 ↘	6: 10.3 ↘	Serie	94
2: 9.1 ↘	7: 9.7 ↘		
3: 10.1 ↘	8: 9.8 ↘	Total	0
4: 9.9 ↘	9: 10.1 ↘		
5: 9.4 ↘	10: 10.8x ↘		

11: 10.1 ←	Serie	10
	Total	0

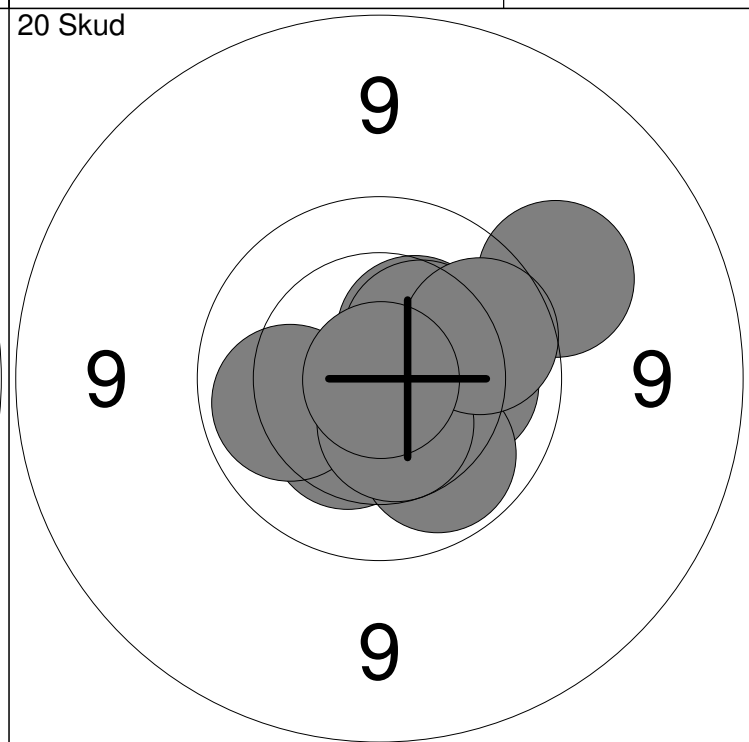
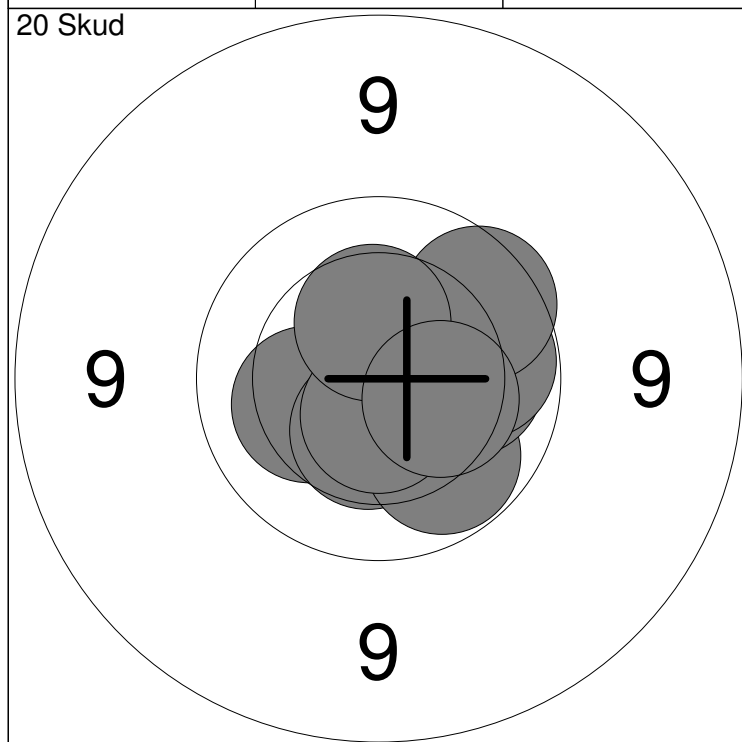

1: 10.2 ←	6: 10.0 →	Serie	99
2: 10.4 →	7: 10.6x ↓		
3: 10.4 ↓	8: 9.8 ↗	Total	99
4: 10.0 ↘	9: 10.4 ↑		
5: 10.1 →	10: 10.3 ↘		

11: 10.4 ↘	16: 10.0 ↘	Serie	98
12: 10.4 ↗	17: 9.4 ↗		
13: 10.4 ↗	18: 10.5x ↓	Total	197
14: 10.1 ←	19: 9.9 ↗		
15: 10.2 →	20: 10.9x ↓		

Hold	Skive	Magnus Kristensen	
1	2		
15m	Vodskov Skytteforening	BK1	
30.01.2015	Nordjysk mesterskab 2015	Aalborg Skyttekreds	
Prøve		1: 10.2	←
		2: 10.3	↓
		3: 10.4	↙
		4: 10.3	↗
		5: 10.3	↗
		6: 10.5x	→
		Serie	60.0
		Total	0.0
20 Skud		1: 10.1	↙
		2: 10.6x	↑
		3: 10.2	↙
		4: 10.6x	↙
		5: 10.8x	←
		6: 10.6x	↙
		7: 10.9x	↙
		8: 9.8	↗
		9: 10.9x	↗
		10: 10.6x	↙
		Serie	99.0
		Total	99.0
20 Skud		11: 10.6x	↗
		12: 10.6x	↗
		13: 10.1	↙
		14: 10.3	↙
		15: 10.9x	↑
		16: 10.8x	←
		17: 10.3	←
		18: 10.1	↑
		19: 10.7x	↓
		20: 10.0	↙
		Serie	100.0
		Total	199.0

Hold 1	Skive 3	Mikkel Larsen
-------------------------	--------------------------	----------------------

15m	Vodskov Skytteforening	BK3
-----	------------------------	-----

30.01.2015	Nordjysk mesterskab 2015	Aalborg Skyttekreds
------------	--------------------------	---------------------

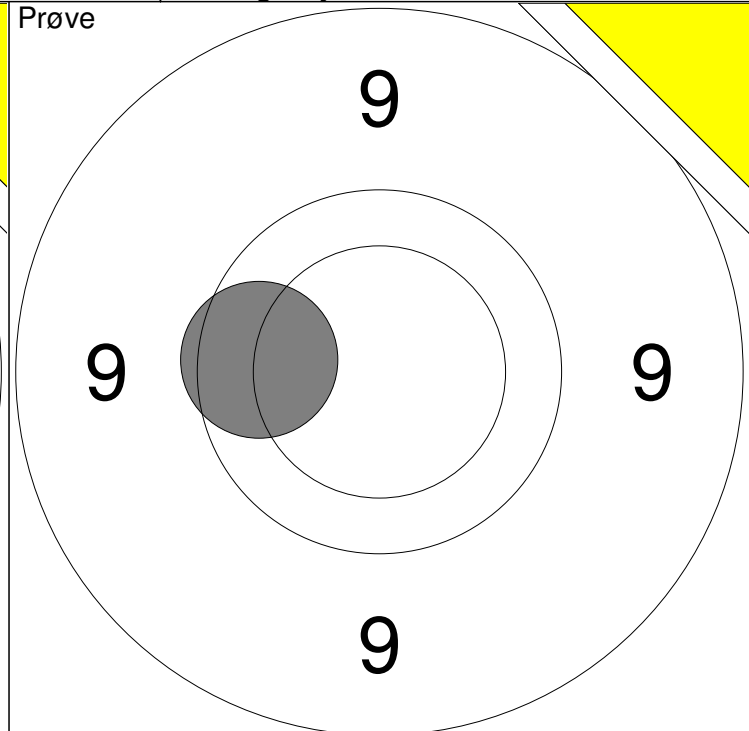
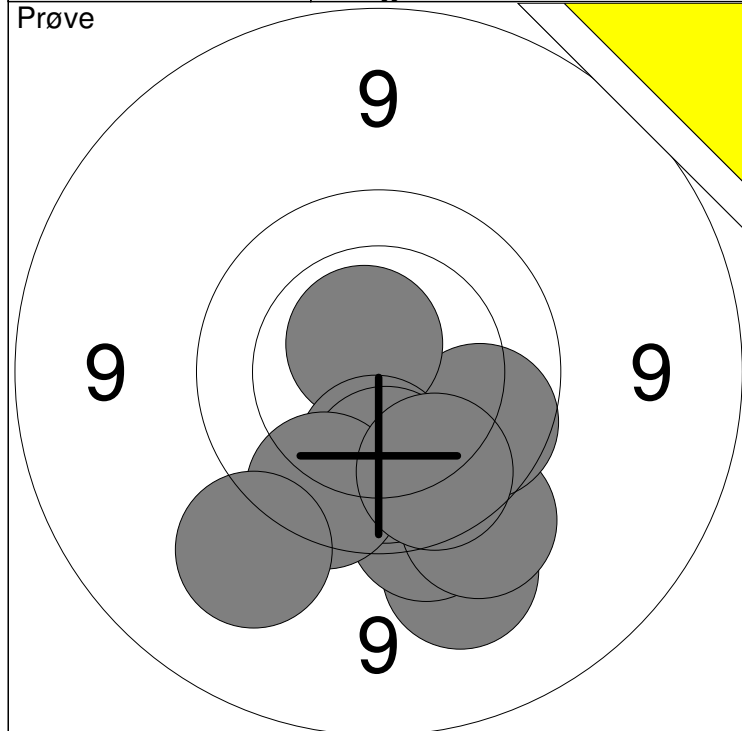

1: 9.3 ↓	6: 10.2 ↓	Serie	93
2: 9.6 ↓	7: 10.0 ↓		
3: 9.5 ↓	8: 9.8 ↓	Total	0
4: 9.9 ↓	9: 9.3 ↓		
5: 10.6x ↗	10: 9.9 ↓		

11: 9.9 ←	Serie	9
	Total	0

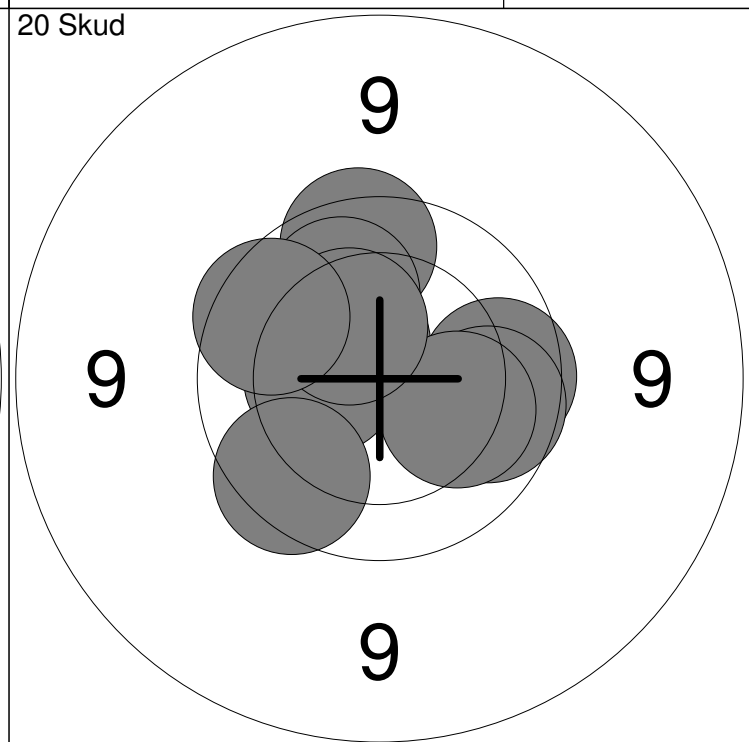
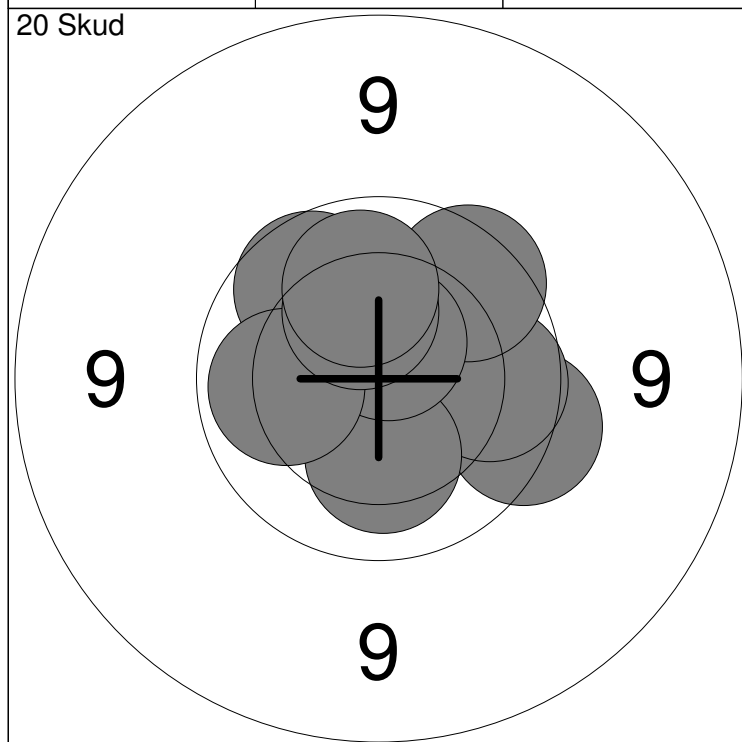

1: 10.8x →	6: 9.8 ↗	Serie	96
2: 9.7 →	7: 10.6x ↑		
3: 9.9 →	8: 10.1 ←	Total	96
4: 9.9 ↗	9: 10.3 ↑		
5: 10.2 ↓	10: 10.1 ↑		

11: 10.5x ↗	16: 9.9 →	Serie	95
12: 9.9 →	17: 9.8 ↓		
13: 10.4 ←	18: 10.1 →	Total	191
14: 9.8 ↑	19: 10.4 ↗		
15: 10.1 ↗	20: 9.8 ↖		

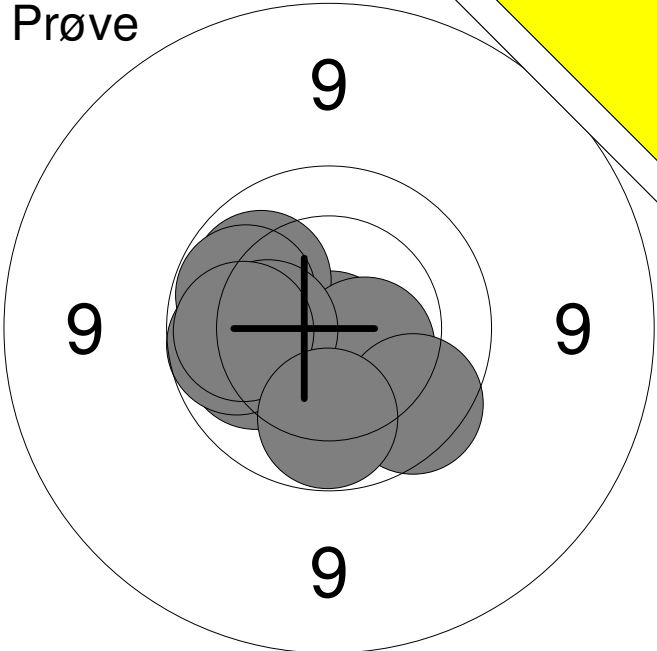
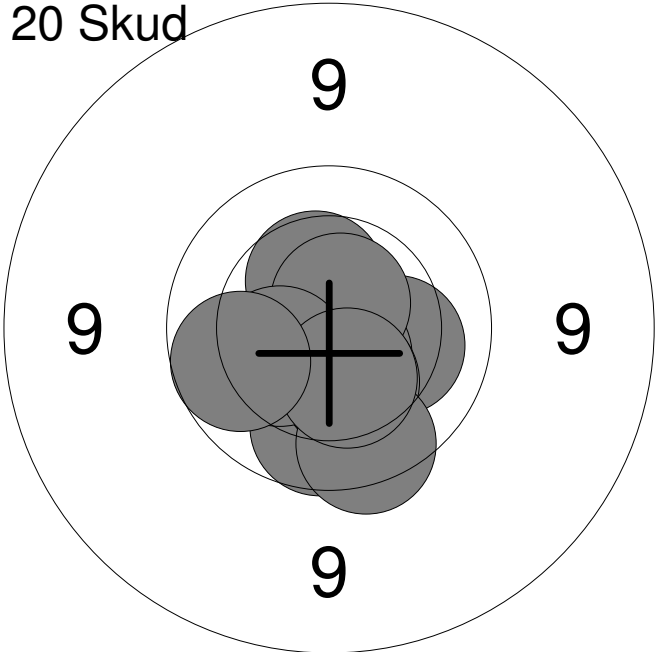
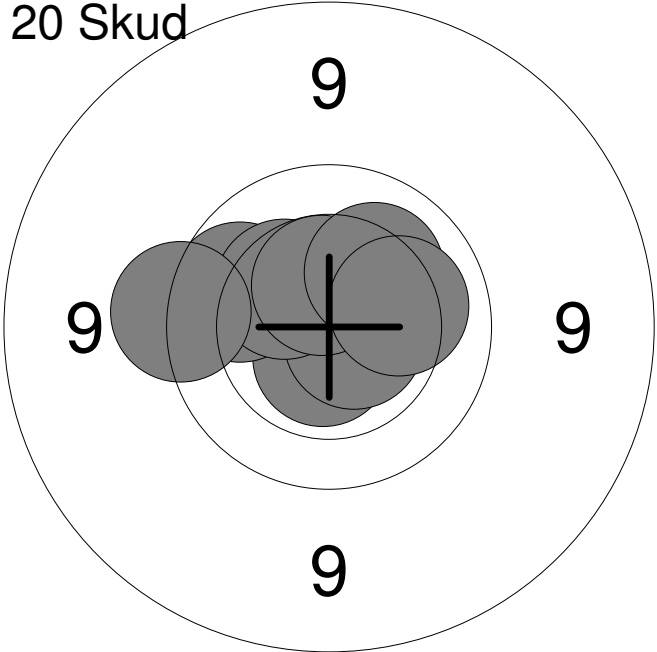
Hold	Skive	Sarah Frankfurth	
1	6		
15m	Aalborg Skyttekreds	BK3	
30.01.2015	Nordjysk mesterskab 2015	Aalborg Skyttekreds	
Prøve 	1:	10.8x	↓
	2:	10.1	↗
	3:	10.5x	↘
	4:	10.1	↖
	5:	10.0	↗
	6:	9.9	↖
	7:	10.3	↖
	8:	10.0	↖
	9:	9.8	↘
	10:	10.0	↓
	Serie		98.0
Total		0.0	
20 Skud 	1:	9.9	↓
	2:	10.2	→
	3:	10.4	↗
	4:	10.6x	↘
	5:	10.3	↘
	6:	10.6x	↗
	7:	10.3	↖
	8:	9.8	↘
	9:	10.4	↘
	10:	9.9	↖
	Serie		97.0
Total		97.0	
20 Skud 	11:	10.6x	↓
	12:	10.5x	↑
	13:	10.5	↗
	14:	9.9	↖
	15:	10.7x	↘
	16:	10.3	↗
	17:	10.5	↑
	18:	10.2	↗
	19:	10.2	→
	20:	9.6	↖
	Serie		98.0
Total		195.0	

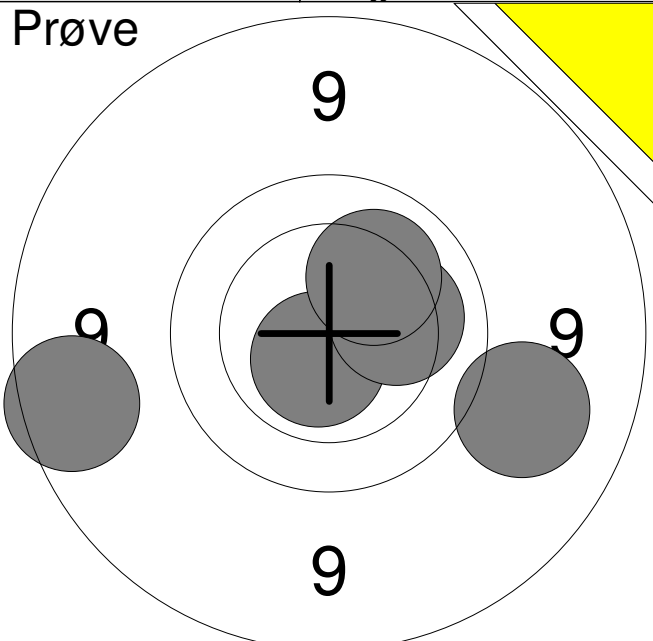
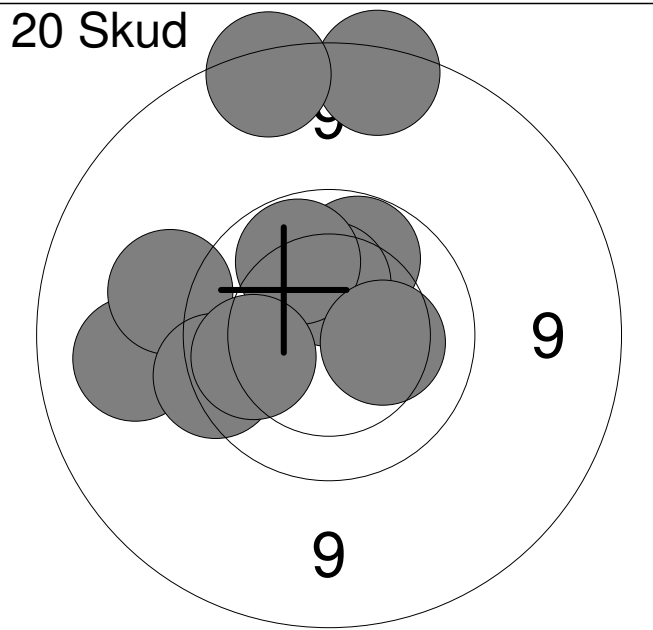
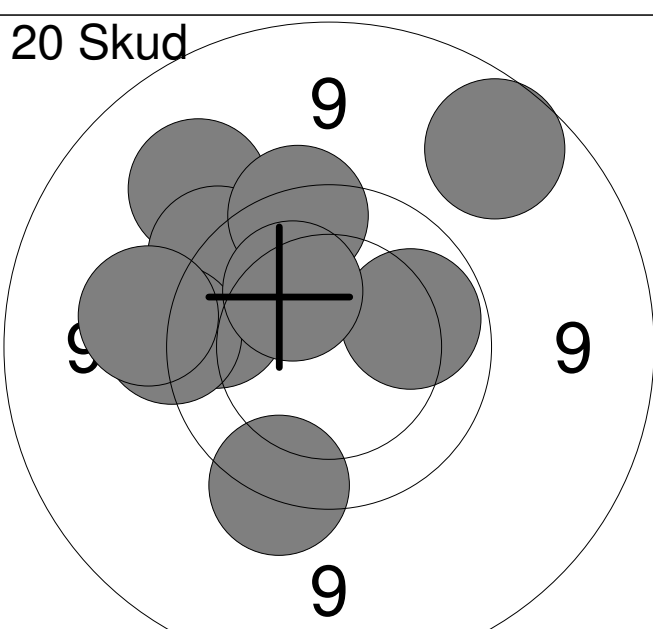
Hold	Skive	Silas Frankfurth		
1	7	Aalborg Skyttekreds		BK4
15m	Nordjysk mesterskab 2015		Aalborg Skyttekreds	
30.01.2015				
Prøve 	1:	10.6x	↘	
	2:	8.9	←	
	3:	9.2	→	
	4:	10.2	→	
	5:	10.2	↗	
	Serie	47.0		
	Total	0.0		
20 Skud 	1:	10.0	↑	
	2:	8.8	↑	
	3:	10.3	↑	
	4:	10.0	↑	
	5:	9.2	←	
	6:	9.4	←	
	7:	9.7	←	
	8:	10.0	←	
	9:	10.3	→	
	10:	8.8	↑	
	Serie	93.0		
	Total	93.0		
20 Skud 	11:	9.3	↗	
	12:	9.8	←	
	13:	9.6	↗	
	14:	10.0	→	
	15:	9.7	↑	
	16:	9.5	←	
	17:	9.4	←	
	18:	8.9	↗	
	19:	9.6	↘	
	20:	10.2	↗	
	Serie	91.0		
	Total	184.0		

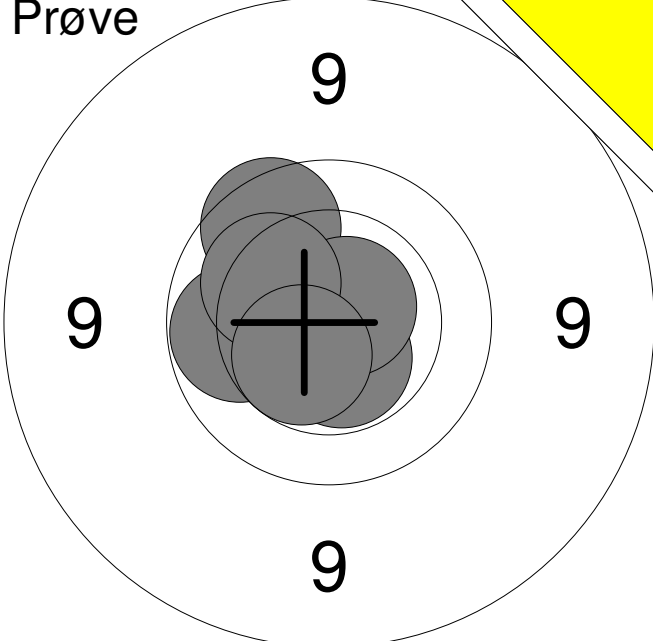
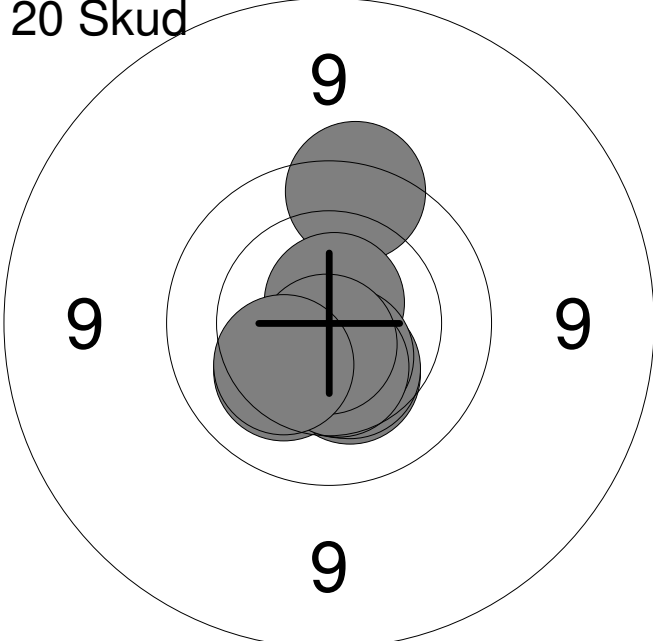
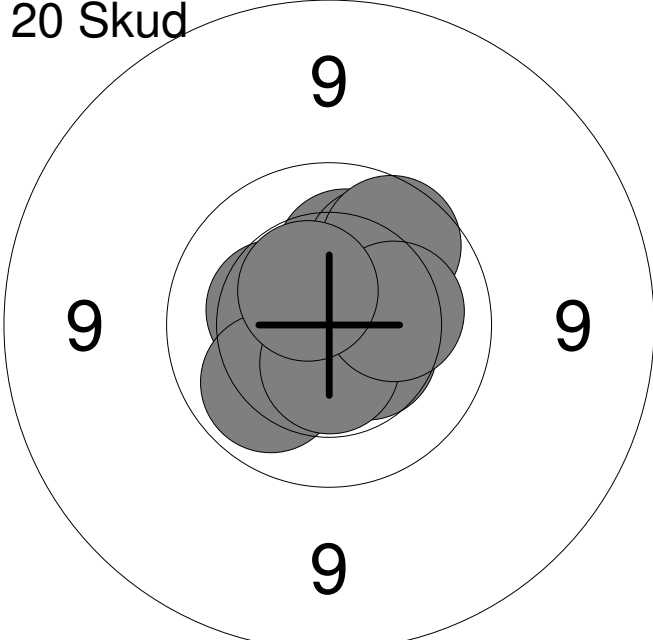
Hold	Skive	Jean Jasinski		
1	10	Aalborg Skyttekreds		J2
15m		Aalborg Skyttekreds		
30.01.2015		Nordjysk mesterskab 2015	Aalborg Skyttekreds	
Prøve		1:	10.5x	↘
		2:	10.0	←
		3:	9.8	↗
		4:	10.7x	↗
		5:	10.2	↗
		6:	10.5	↘
		Serie	59.0	
		Total	0.0	
20 Skud		1:	10.4	↘
		2:	9.7	↑
		3:	10.2	↙
		4:	10.5	↘
		5:	10.7x	↑
		6:	10.4	↘
		7:	10.6x	↘
		8:	10.5	↘
		9:	10.7x	↘
		10:	10.3	↙
		Serie	99.0	
		Total	99.0	
20 Skud		11:	10.4	↑
		12:	10.4	←
		13:	10.2	↑
		14:	10.1	↗
		15:	10.5	↘
		16:	10.1	↙
		17:	9.9	↗
		18:	10.5x	↘
		19:	10.2	→
		20:	10.5x	↗
		Serie	99.0	
		Total	198.0	

Hold 2	Skive 1	Louise Krogsgaard
------------------	-------------------	--------------------------

15m	Vodskov Skytteforening	BK3
-----	------------------------	-----

30.01.2015	Nordjysk mesterskab 2015	Aalborg Skyttekreds
------------	--------------------------	---------------------

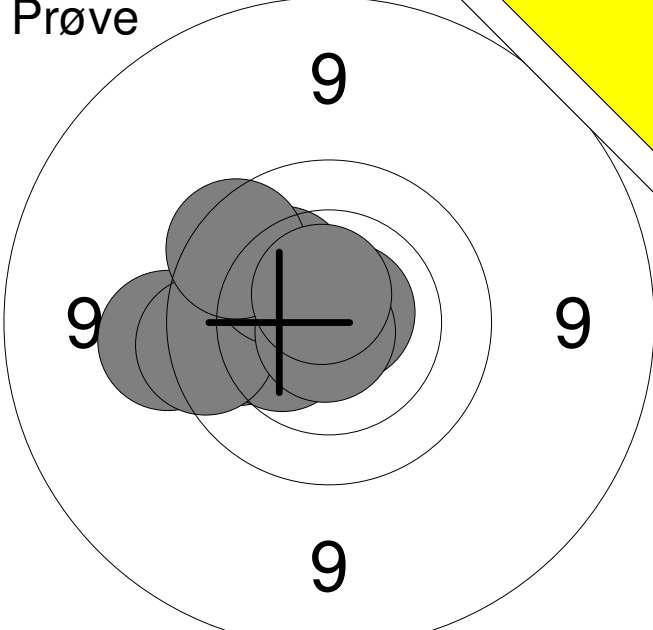
Prøve 	1:	9.5	←
	2:	10.0	←
	3:	10.4	←
	4:	9.7	←
	5:	10.7x	↗
	6:	10.2	↗
	7:	9.8	↗
	8:	10.8x	↓
	9:	10.6x	↑
	Serie		87.0
Total		0.0	

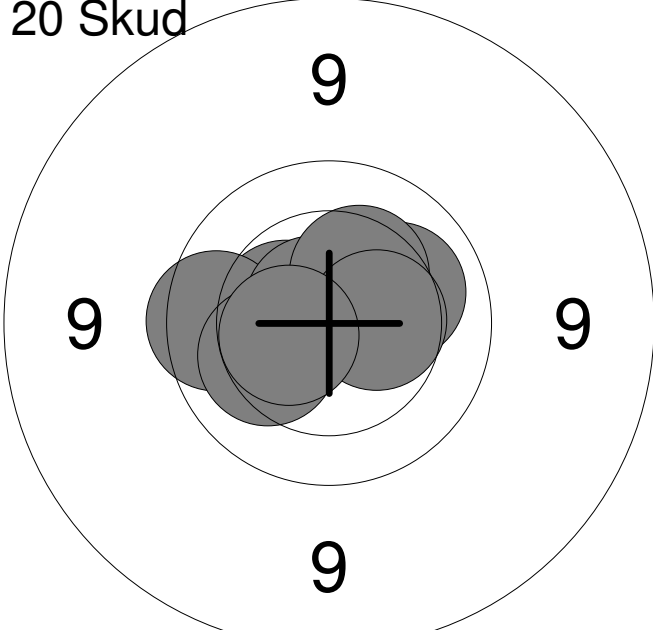
20 Skud 	1:	10.5	←
	2:	9.8	←
	3:	10.7x	↑
	4:	10.2	←
	5:	10.3	↗
	6:	10.2	↗
	7:	10.7x	↗
	8:	10.3	↑
	9:	10.4	→
	10:	10.5x	←
Serie		99.0	
Total		99.0	

20 Skud 	11:	10.6x	→
	12:	10.7x	↑
	13:	10.1	↗
	14:	10.7x	←
	15:	10.4	↗
	16:	10.3	→
	17:	10.4	↑
	18:	10.6x	↓
	19:	10.4	←
	20:	10.6x	↘
Serie		100.0	
Total		199.0	

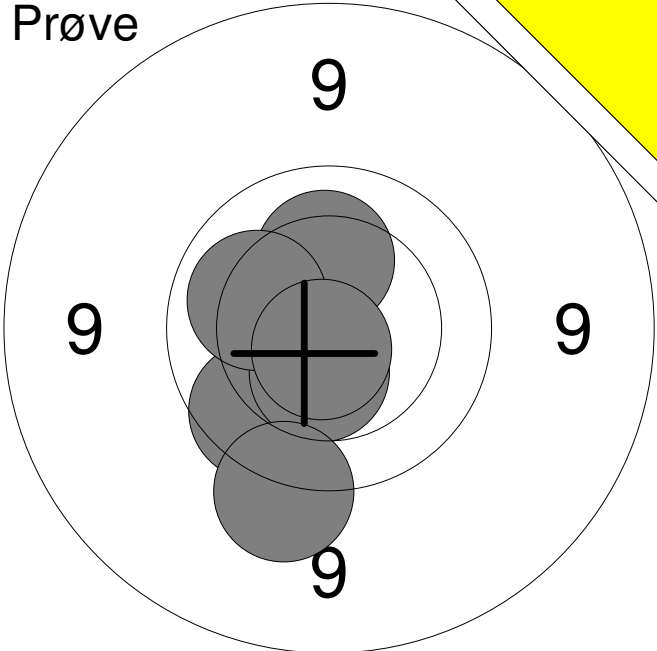
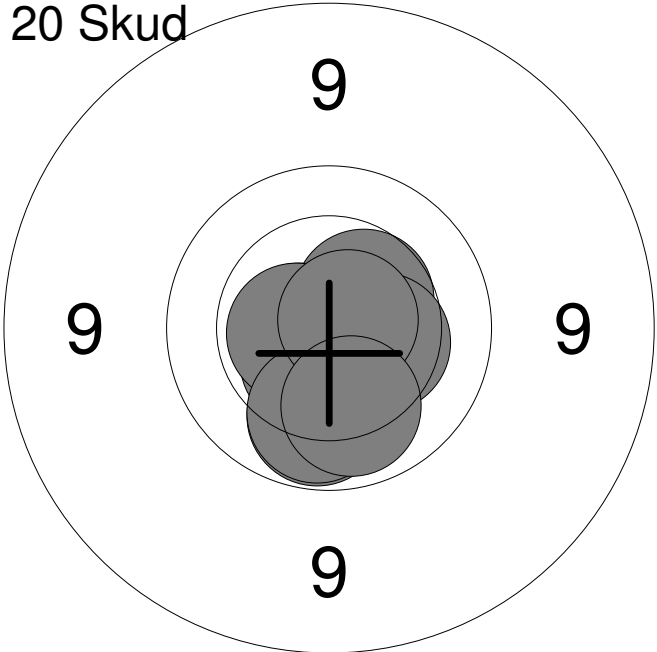
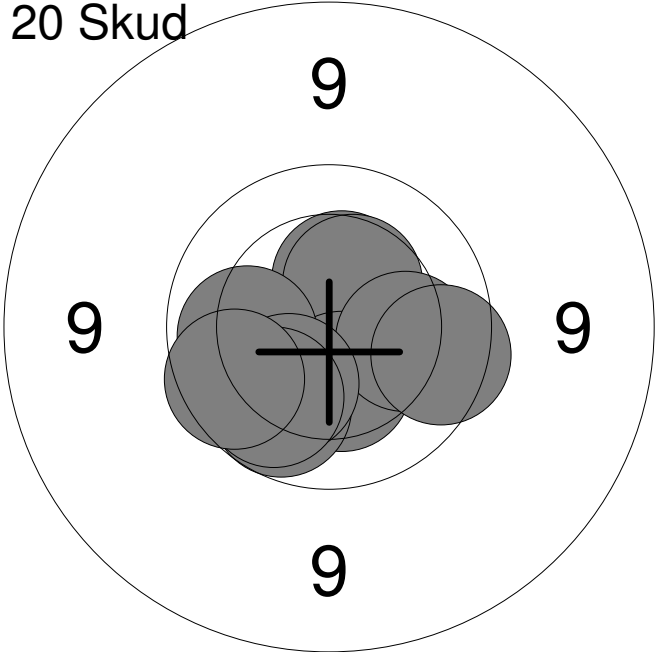
Hold	Skive	Sarah Frankfurth		
2	6	Aalborg Skyttekreds		MB3
15m	Nordjysk mesterskab 2015		Aalborg Skyttekreds	
30.01.2015				
Prøve		1:	10.6x	←
		2:	9.9	↙
		3:	10.5	↓
		4:	9.5	↓
		5:	10.2	↑
		6:	10.1	↖
		7:	10.7x	↓
		Serie	68.0	
		Total	0.0	
20 Skud		1:	10.2	↓
		2:	10.5	↗
		3:	10.5x	↓
		4:	10.0	↓
		5:	10.6x	←
		6:	10.6x	←
		7:	10.0	↓
		8:	10.4	→
		9:	10.7x	→
		10:	10.1	↓
		Serie	100.0	
		Total	100.0	
20 Skud		11:	10.4	↑
		12:	10.4	↗
		13:	10.3	↓
		14:	10.1	→
		15:	9.9	↙
		16:	10.1	←
		17:	10.2	↙
		18:	10.0	↙
		19:	9.9	↖
		20:	9.8	→
		Serie	97.0	
		Total	197.0	

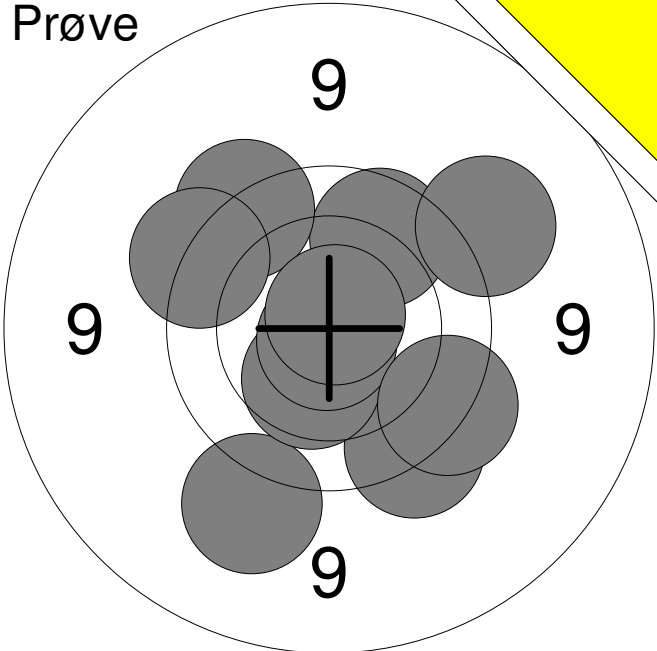
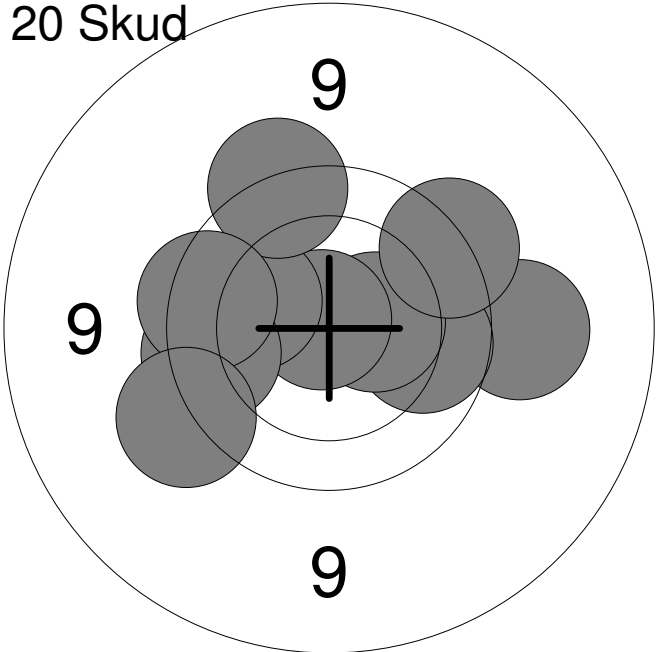
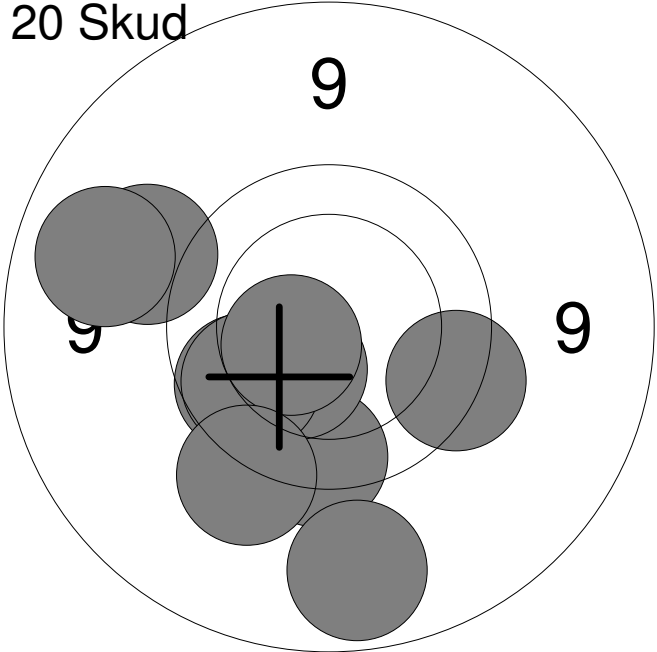
Hold	Skive	Silas Frankfurth	
2	7		
15m	Aalborg Skyttekreds	MB4	
30.01.2015	Nordjysk mesterskab 2015	Aalborg Skyttekreds	
Prøve 	1:	9.6	↘
	2:	9.3	↘
	3:	10.4	↘
	4:	10.8x	↘
	5:	9.9	↗
	6:	9.6	↗
	7:	9.6	↗
	8:	9.4	↗
	9:	9.6	↘
	10:	10.8x	↗
	Serie		93.0
Total		0.0	
20 Skud 	1:	9.3	→
	2:	9.9	→
	3:	10.4	→
	4:	9.6	↗
	5:	10.8x	↗
	6:	10.1	↗
	7:	9.8	←
	8:	9.6	↗
	9:	9.8	←
	10:	9.5	↙
	Serie		93.0
Total		93.0	
20 Skud 	11:	9.3	↖
	12:	9.7	↘
	13:	9.1	↖
	14:	10.4	↙
	15:	9.0	↘
	16:	9.9	↖
	17:	9.9	↖
	18:	10.5x	↖
	19:	9.7	↗
	20:	9.5	↙
	Serie		92.0
Total		185.0	

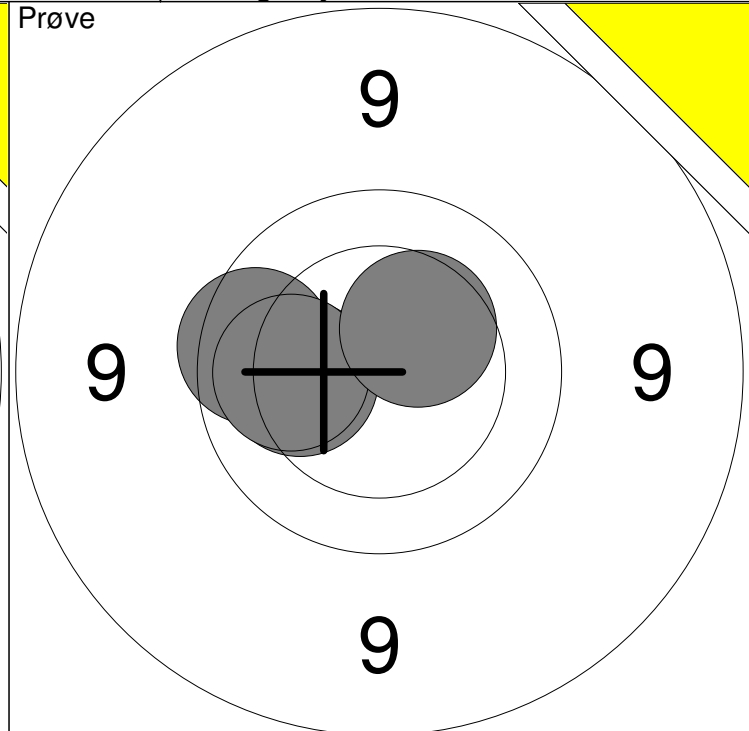
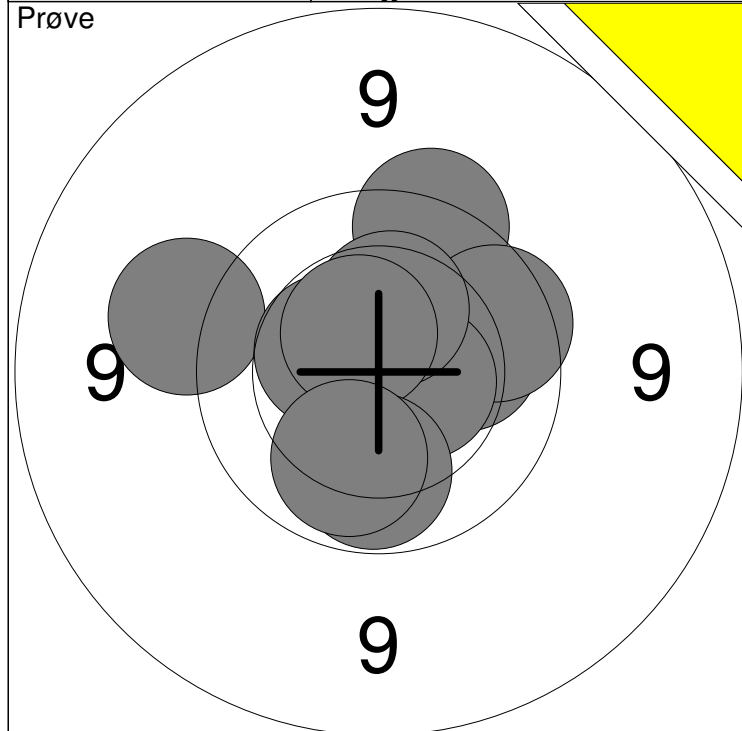

1: 10.1 →	6: 10.5 ↙	Serie	97
2: 9.7 ↑	7: 10.3 ↑		
3: 9.8 →	8: 10.5x ↙	Total	0
4: 10.6x →	9: 10.0 ↓		
5: 9.4 ↙	10: 10.1 ↓		

11: 9.8 ↙	Serie	39
12: 10.2 ↙		
13: 10.1 ↙	Total	0
14: 10.4 ↗		

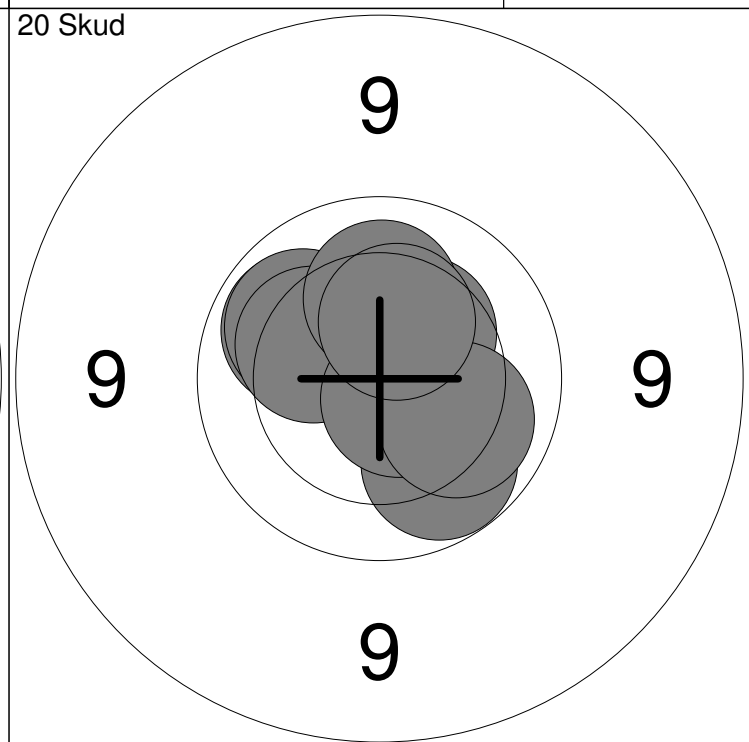
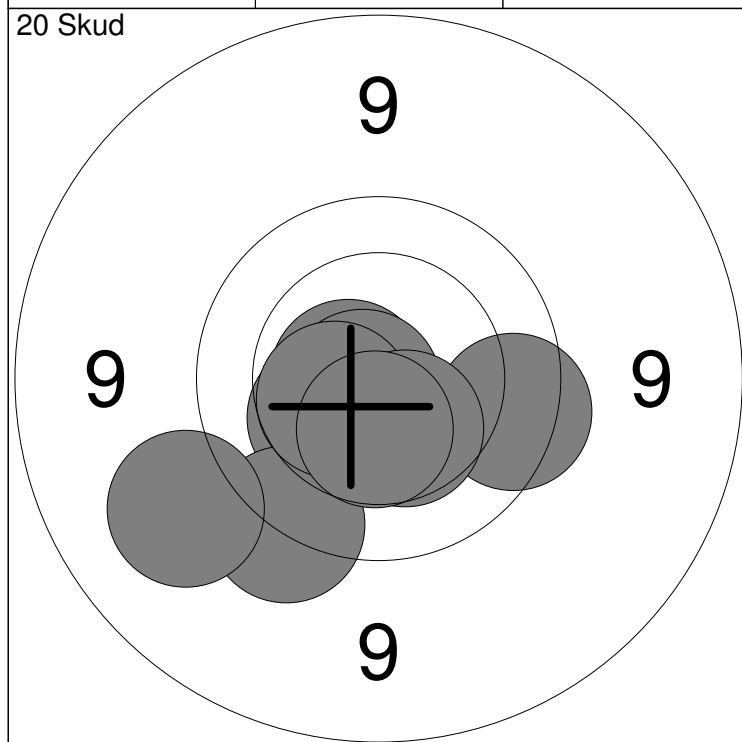

1: 10.5 ↙	6: 10.8x ↙	Serie	97
2: 10.7x ↙	7: 9.8 →		
3: 10.3 ↙	8: 10.5 ↙	Total	97
4: 9.6 ↙	9: 10.4 ↓		
5: 9.2 ↙	10: 10.5 ↓		

11: 10.0 ↗	16: 10.0 ↓	Serie	100
12: 10.2 ↗	17: 10.7x ↓		
13: 10.4 ↗	18: 10.1 ↓	Total	197
14: 10.1 ↗	19: 10.2 ↑		
15: 10.2 ↙	20: 10.4 ↑		

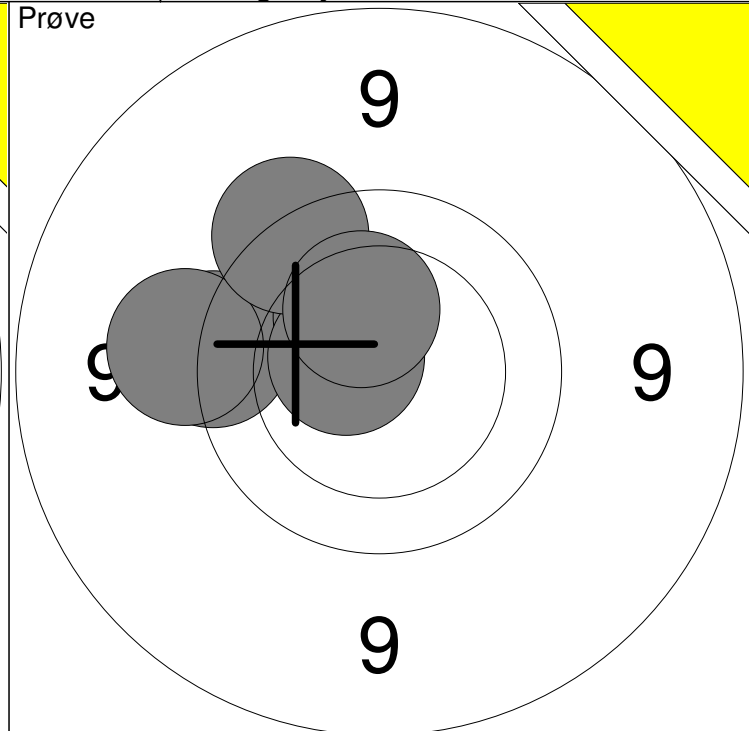
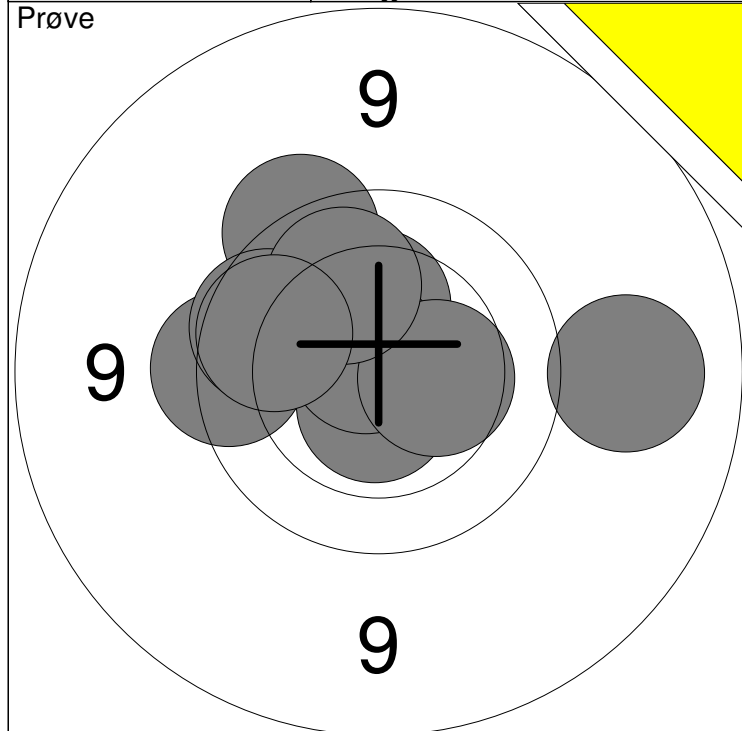

1: 9.2 →	6: 10.7x ↗	Serie	95
2: 10.6x ↓	7: 9.9 ↖		
3: 9.7 ←	8: 10.4 →	Total	0
4: 10.3 ↑	9: 10.0 ↗		
5: 9.6 ↖	10: 9.9 ↖		

11: 9.6 ←	16: 10.3 ↑	Serie	57
12: 9.4 ←			
13: 10.4 ↗		Total	0
14: 10.6x ↗			
15: 9.6 ↗			

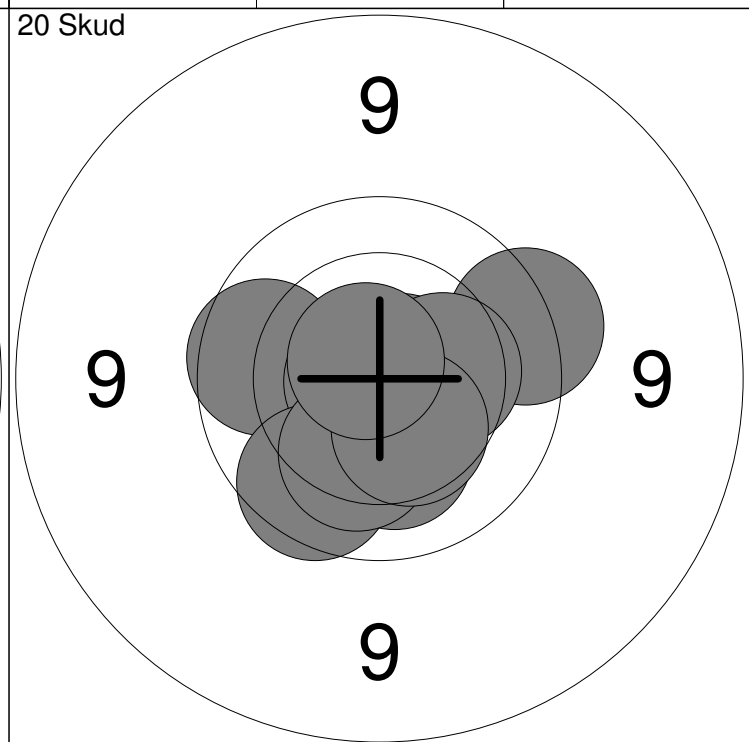
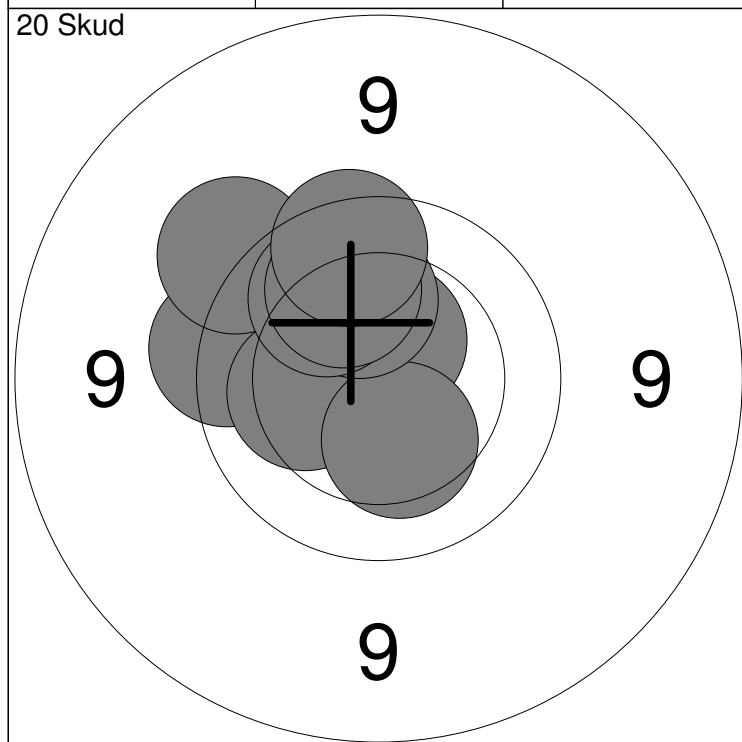

1: 9.7 ←	6: 10.3 ↓	Serie	97
2: 9.5 ↗	7: 10.2 ↑		
3: 10.2 ↑	8: 10.0 ↗	Total	97
4: 10.6x ↑	9: 10.0 ↗		
5: 10.2 ←	10: 9.8 ↗		

11: 10.7x →	16: 10.3 →	Serie	97
12: 10.2 ↓	17: 9.9 ↓		
13: 9.9 ←	18: 10.2 ↓	Total	194
14: 9.7 →	19: 10.4 ↓		
15: 10.8x ←	20: 10.7x ↗		

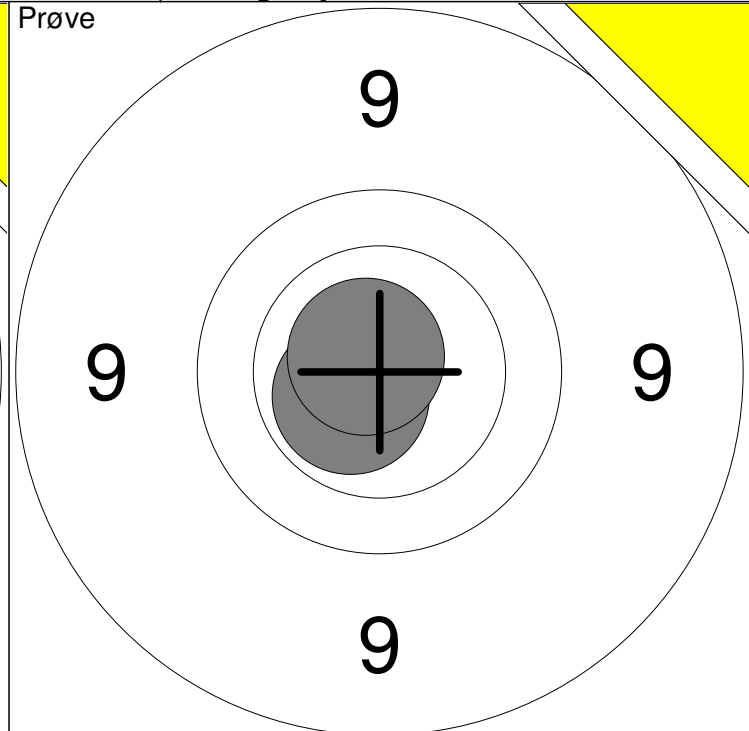
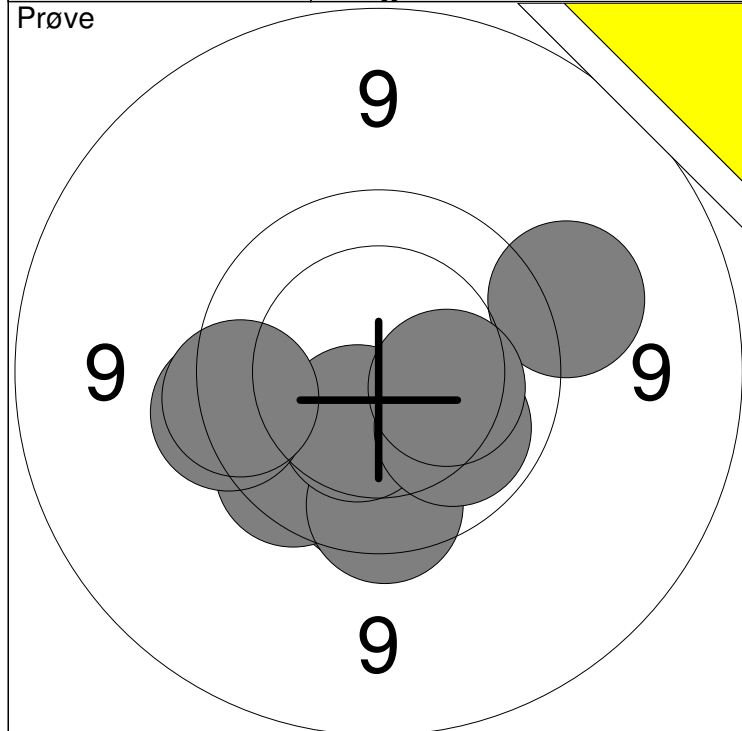

1: 9.4 →	6: 10.4 ↓	Serie	93
2: 9.9 ↓	7: 10.1 ↓		
3: 9.9 ↓	8: 10.3 →	Total	0
4: 9.8 ↙	9: 9.7 ←		
5: 9.8 ↓	10: 9.7 ←		

11: 10.6x ↙	Serie	20
12: 10.8x ↗		
Total		0

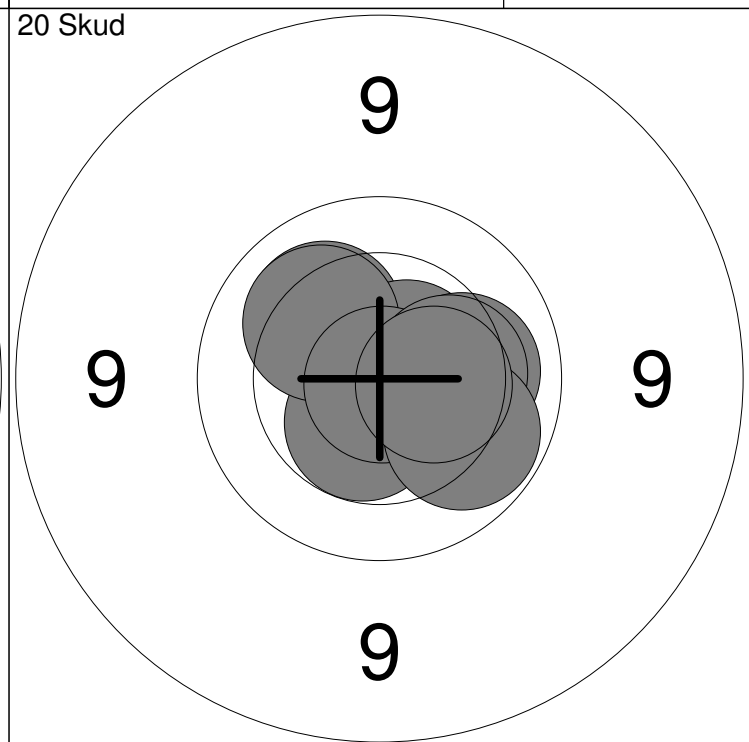
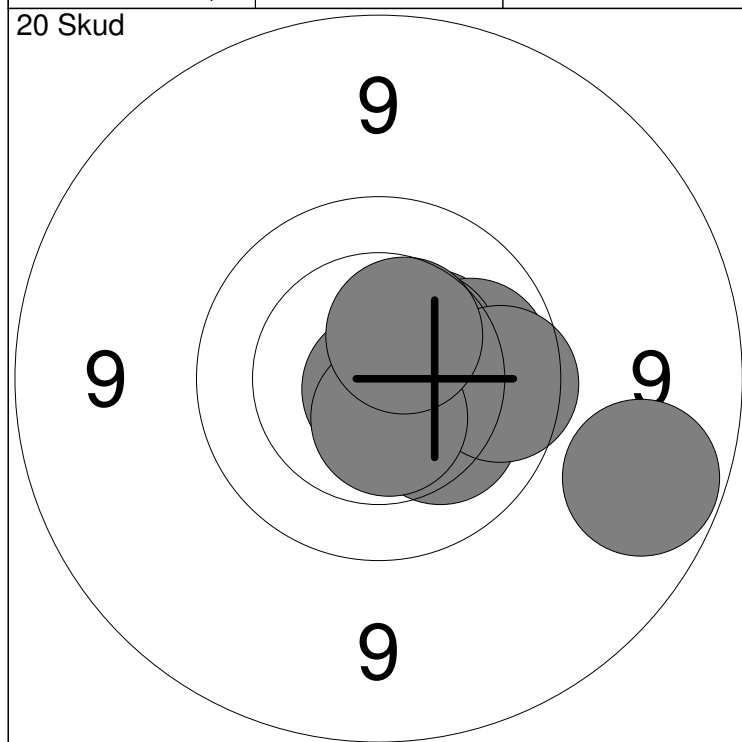

1: 9.0 →	6: 10.0 →	Serie	98
2: 10.8x ↓	7: 10.4 ↗		
3: 10.2 ↘	8: 9.9 →	Total	98
4: 10.4 ↗	9: 10.6x ↓		
5: 10.1 →	10: 10.5 ↗		

11: 10.2 →	16: 10.2 ↗	Serie	100
12: 10.2 ↗	17: 10.9x ↓		
13: 10.5x ↓	18: 10.3 →	Total	198
14: 10.6x ↗	19: 10.0 ↓		
15: 10.1 →	20: 10.4 →		

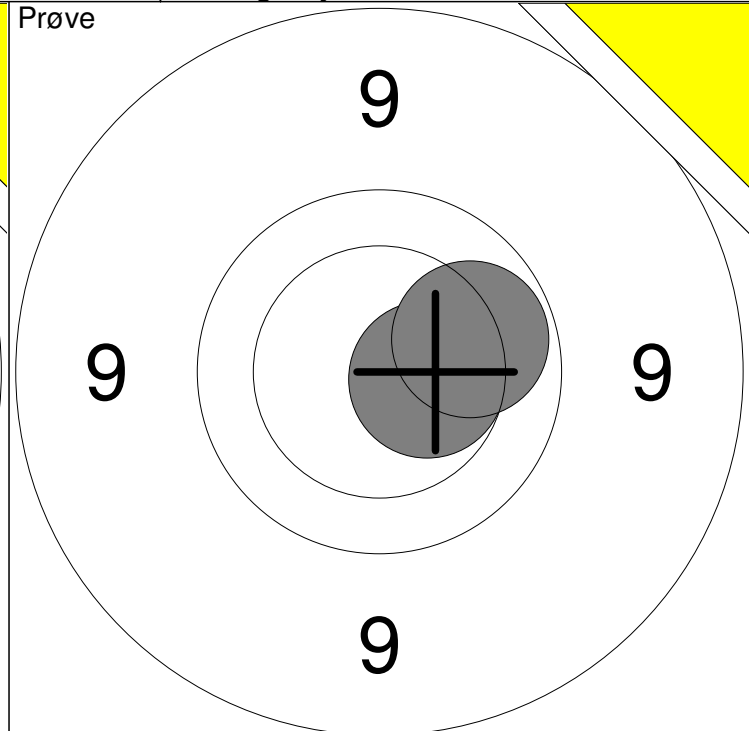
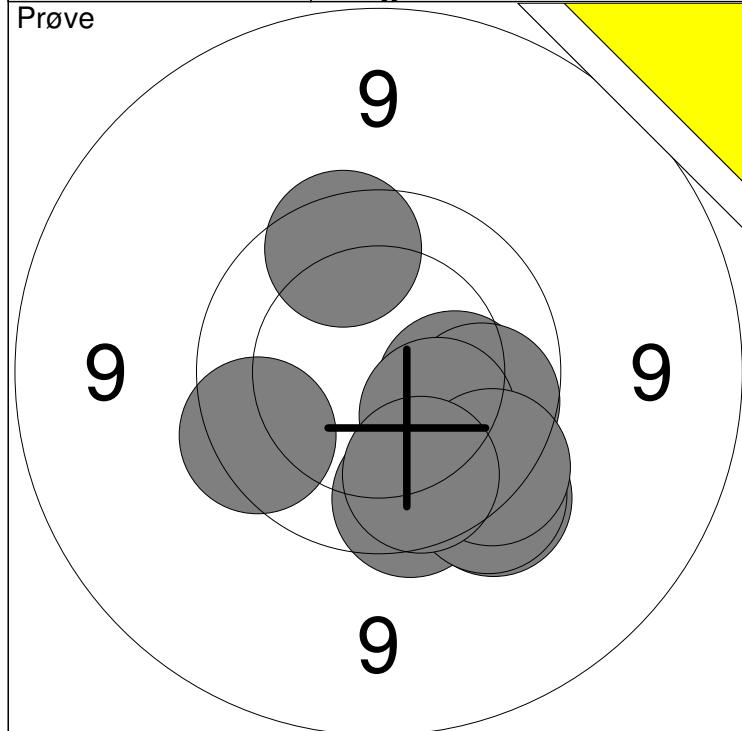

1: 9.8 ↗	6: 10.2 ↘	Serie	92
2: 9.6 ↘	7: 9.8 ↙		
3: 9.8 ↘	8: 9.6 ↘	Total	0
4: 10.2 →	9: 9.7 ↘		
5: 9.9 →	10: 9.9 ↘		

11: 10.5 →	Serie	20
12: 10.0 →		
Total		0

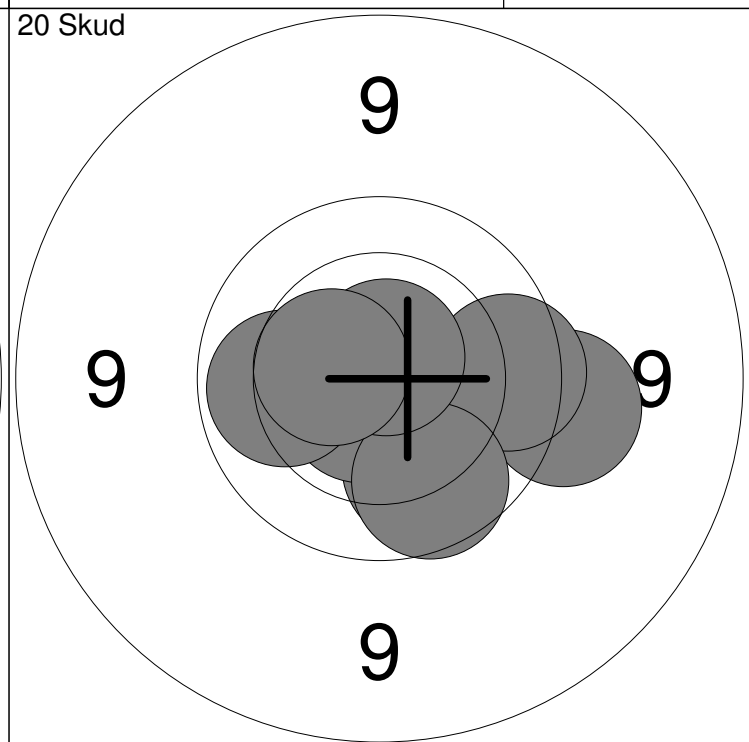
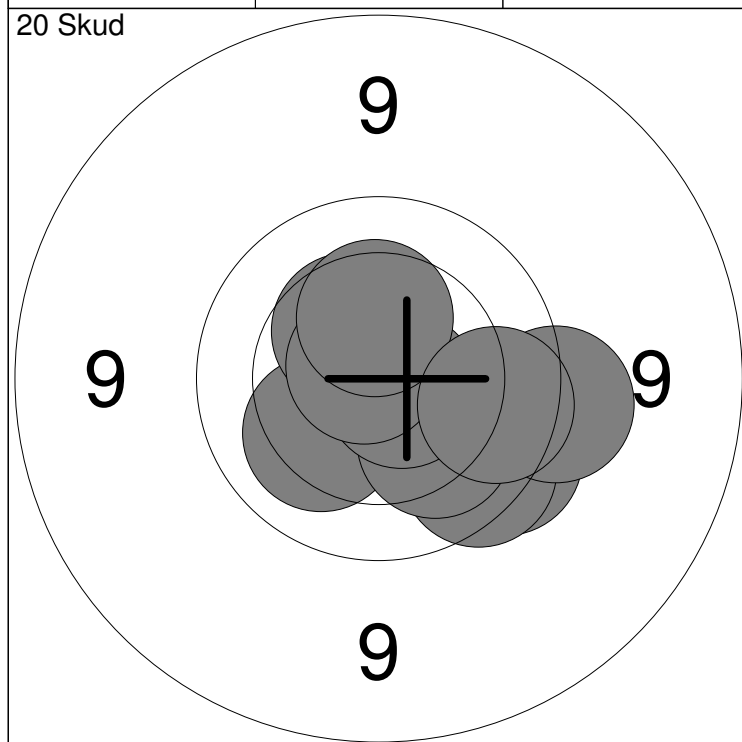

1: 9.7 ↘	6: 10.7x ↘	Serie	96
2: 9.8 ↘	7: 9.5 →		
3: 10.2 ↙	8: 10.8x ↗	Total	96
4: 10.1 ↘	9: 10.4 ↗		
5: 10.4 ↗	10: 9.9 →		

11: 10.0 ↘	16: 9.8 →	Serie	97
12: 10.7x ↘	17: 9.9 ↘		
13: 10.6x ↙	18: 10.7x ↗	Total	193
14: 10.1 →	19: 10.0 ←		
15: 9.5 →	20: 10.5 ←		

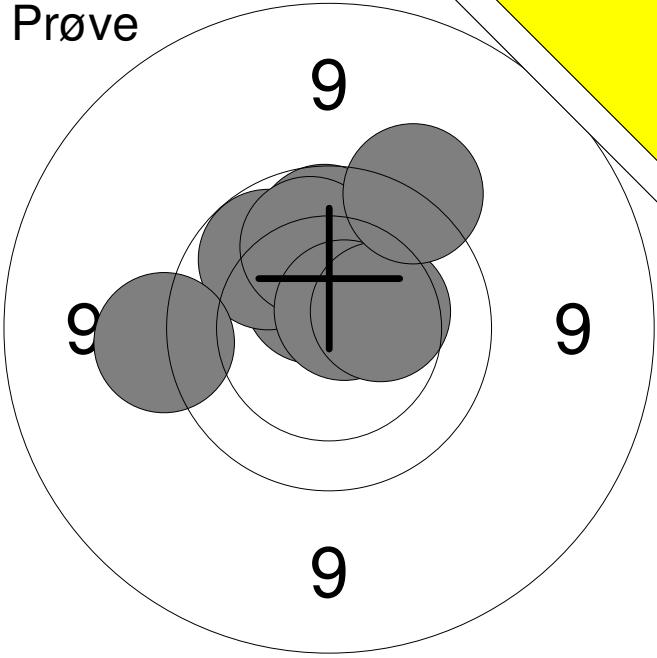
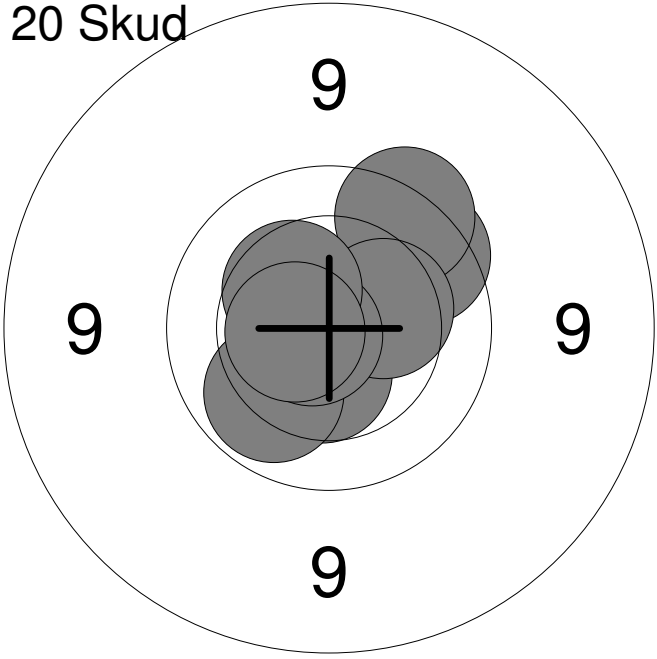
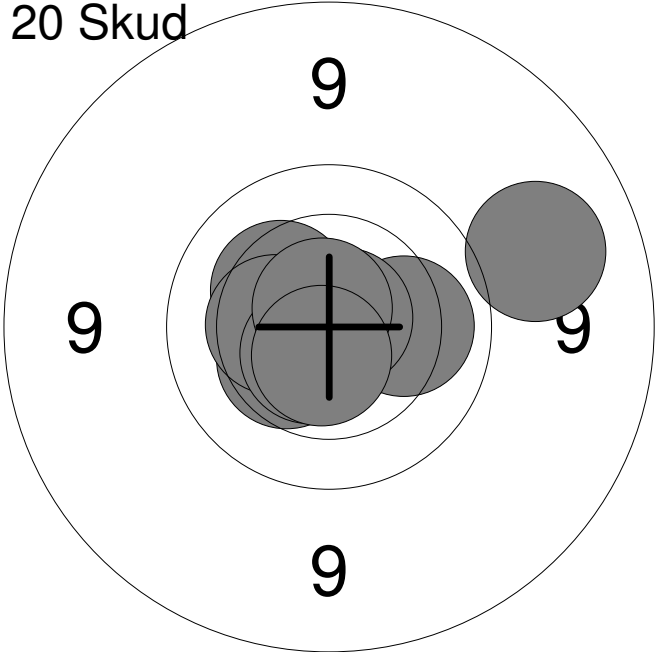
Hold	Skive		
3	5	Mie Larsen	
15m	Vester Han Herred SkytteforeningBK2	BK2	
30.01.2015	Nordjysk mesterskab 2015	Aalborg Skyttekreds	
Prøve		1: 10.5x	↖
		2: 9.9	↑
		3: 10.0	↖
		4: 9.5	←
		5: 10.0	↑
		6: 10.7x	↗
		7: 10.4	→
		8: 9.5	↗
		Serie	77.0
		Total	0.0
20 Skud		1: 10.5	↓
		2: 10.0	↙
		3: 9.8	↗
		4: 10.7x	←
		5: 10.6x	↑
		6: 9.7	↗
		7: 10.3	→
		8: 10.8x	←
		9: 10.4	↗
		10: 10.6x	←
		Serie	98.0
		Total	98.0
20 Skud		11: 10.7x	→
		12: 10.3	↖
		13: 9.2	→
		14: 10.4	↙
		15: 10.1	→
		16: 10.8x	↗
		17: 10.4	←
		18: 10.6x	↙
		19: 10.7x	↑
		20: 10.6x	↓
		Serie	99.0
		Total	197.0

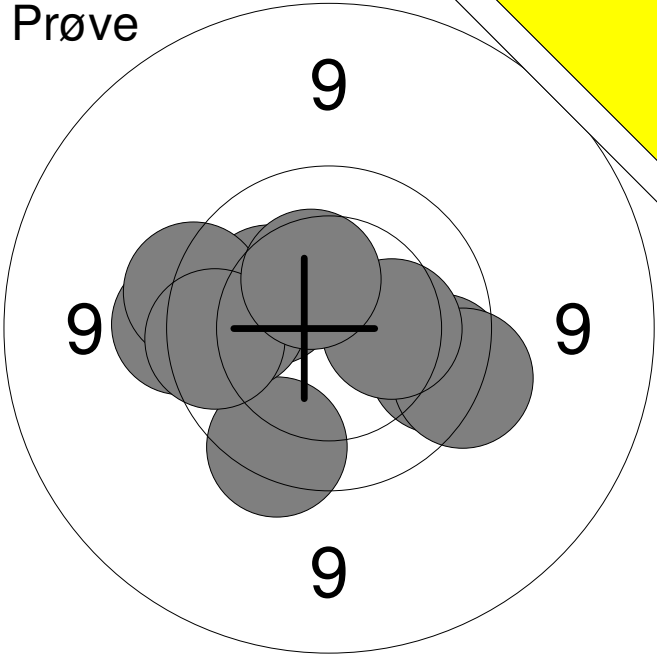
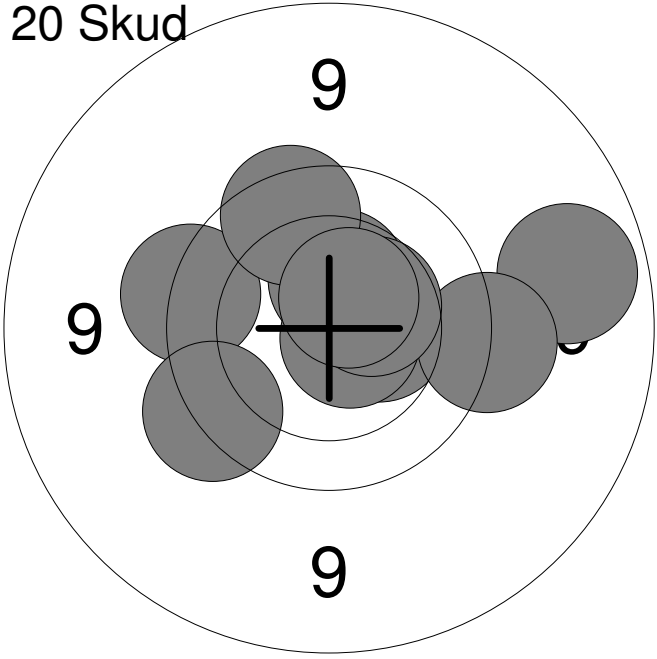
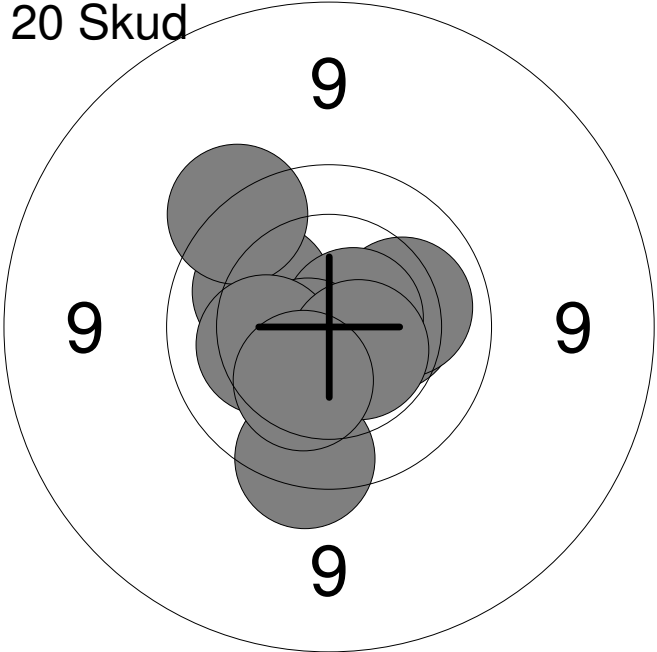
Hold	Skive	Jonas N. Rasmussen	
3	6	15m	Skf. Kimbrene J2
30.01.2015	Nordjysk mesterskab 2015	Aalborg Skyttekreds	
Prøve 	1:	9.8	→
	2:	9.7	↓
	3:	9.6	→
	4:	10.3	→
	5:	9.6	←
	6:	10.2	↗
	7:	10.0	←
	8:	9.7	←
	9:	9.8	←
	10:	10.4	↑
	Serie		94.0
Total		0.0	
20 Skud 	1:	10.4	↑
	2:	9.6	←
	3:	9.6	↙
	4:	9.0	→
	5:	9.8	↑
	6:	10.4	→
	7:	10.7x	→
	8:	9.5	→
	9:	10.4	↗
	10:	10.6x	↗
	Serie		95.0
Total		95.0	
20 Skud 	11:	10.3	→
	12:	10.1	→
	13:	10.1	↖
	14:	10.7x	→
	15:	9.6	↗
	16:	10.6x	↙
	17:	9.7	↓
	18:	10.2	←
	19:	10.5x	↘
	20:	10.3	↙
	Serie		98.0
Total		193.0	

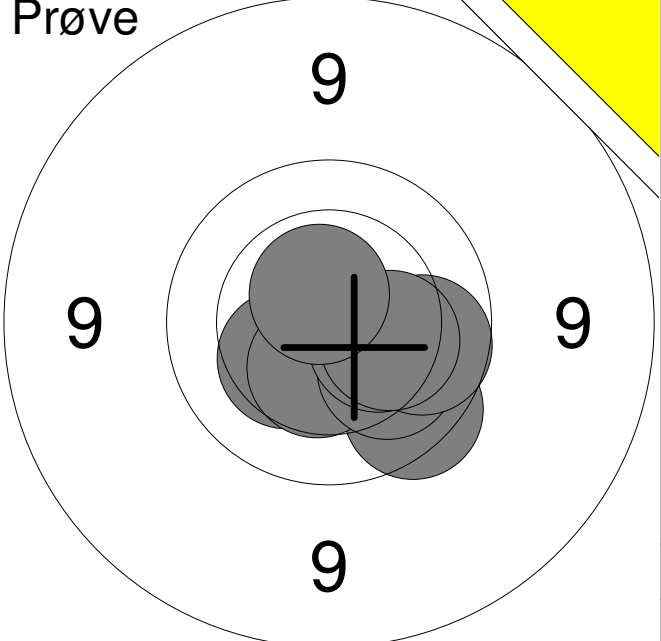
<p>Prøve</p> 	<table style="width:100%; border-collapse: collapse;"> <tr><td style="width:10%;">1:</td><td style="width:70%;">9.8</td><td style="width:20%; text-align:right;">↘</td></tr> <tr><td>2:</td><td>10.4</td><td style="text-align:right;">↙</td></tr> <tr><td>3:</td><td>10.4</td><td style="text-align:right;">↘</td></tr> <tr><td>4:</td><td>10.1</td><td style="text-align:right;">↘</td></tr> <tr><td>5:</td><td>10.4</td><td style="text-align:right;">↘</td></tr> <tr><td>6:</td><td>9.9</td><td style="text-align:right;">→</td></tr> <tr><td>7:</td><td>10.3</td><td style="text-align:right;">→</td></tr> <tr><td>8:</td><td>10.6x</td><td style="text-align:right;">↗</td></tr> </table>	1:	9.8	↘	2:	10.4	↙	3:	10.4	↘	4:	10.1	↘	5:	10.4	↘	6:	9.9	→	7:	10.3	→	8:	10.6x	↗
1:	9.8	↘																							
2:	10.4	↙																							
3:	10.4	↘																							
4:	10.1	↘																							
5:	10.4	↘																							
6:	9.9	→																							
7:	10.3	→																							
8:	10.6x	↗																							
<table style="width:100%; border-collapse: collapse;"> <tr> <td style="width:80%;">Serie</td> <td style="text-align:right;">78.0</td> </tr> <tr> <td>Total</td> <td style="text-align:right;">0.0</td> </tr> </table>		Serie	78.0	Total	0.0																				
Serie	78.0																								
Total	0.0																								

<p>20 Skud</p> 	<table style="width:100%; border-collapse: collapse;"> <tr><td style="width:10%;">1:</td><td style="width:70%;">9.8</td><td style="width:20%; text-align:right;">↗</td></tr> <tr><td>2:</td><td>10.0</td><td style="text-align:right;">↙</td></tr> <tr><td>3:</td><td>10.4</td><td style="text-align:right;">↗</td></tr> <tr><td>4:</td><td>10.6x</td><td style="text-align:right;">↗</td></tr> <tr><td>5:</td><td>10.7x</td><td style="text-align:right;">→</td></tr> <tr><td>6:</td><td>10.5</td><td style="text-align:right;">→</td></tr> <tr><td>7:</td><td>10.4</td><td style="text-align:right;">→</td></tr> <tr><td>8:</td><td>10.4</td><td style="text-align:right;">↘</td></tr> <tr><td>9:</td><td>10.4</td><td style="text-align:right;">↙</td></tr> <tr><td>10:</td><td>10.3</td><td style="text-align:right;">↗</td></tr> </table>	1:	9.8	↗	2:	10.0	↙	3:	10.4	↗	4:	10.6x	↗	5:	10.7x	→	6:	10.5	→	7:	10.4	→	8:	10.4	↘	9:	10.4	↙	10:	10.3	↗
1:	9.8	↗																													
2:	10.0	↙																													
3:	10.4	↗																													
4:	10.6x	↗																													
5:	10.7x	→																													
6:	10.5	→																													
7:	10.4	→																													
8:	10.4	↘																													
9:	10.4	↙																													
10:	10.3	↗																													
<table style="width:100%; border-collapse: collapse;"> <tr> <td style="width:80%;">Serie</td> <td style="text-align:right;">99.0</td> </tr> <tr> <td>Total</td> <td style="text-align:right;">99.0</td> </tr> </table>		Serie	99.0	Total	99.0																										
Serie	99.0																														
Total	99.0																														

<p>20 Skud</p> 	<table style="width:100%; border-collapse: collapse;"> <tr><td style="width:10%;">11:</td><td style="width:70%;">9.9</td><td style="width:20%; text-align:right;">↘</td></tr> <tr><td>12:</td><td>10.8x</td><td style="text-align:right;">↗</td></tr> <tr><td>13:</td><td>10.6x</td><td style="text-align:right;">↘</td></tr> <tr><td>14:</td><td>10.4</td><td style="text-align:right;">↘</td></tr> <tr><td>15:</td><td>10.0</td><td style="text-align:right;">↘</td></tr> <tr><td>16:</td><td>10.6x</td><td style="text-align:right;">→</td></tr> <tr><td>17:</td><td>10.3</td><td style="text-align:right;">→</td></tr> <tr><td>18:</td><td>10.3</td><td style="text-align:right;">↘</td></tr> <tr><td>19:</td><td>10.2</td><td style="text-align:right;">↘</td></tr> <tr><td>20:</td><td>9.9</td><td style="text-align:right;">↙</td></tr> </table>	11:	9.9	↘	12:	10.8x	↗	13:	10.6x	↘	14:	10.4	↘	15:	10.0	↘	16:	10.6x	→	17:	10.3	→	18:	10.3	↘	19:	10.2	↘	20:	9.9	↙
11:	9.9	↘																													
12:	10.8x	↗																													
13:	10.6x	↘																													
14:	10.4	↘																													
15:	10.0	↘																													
16:	10.6x	→																													
17:	10.3	→																													
18:	10.3	↘																													
19:	10.2	↘																													
20:	9.9	↙																													
<table style="width:100%; border-collapse: collapse;"> <tr> <td style="width:80%;">Serie</td> <td style="text-align:right;">98.0</td> </tr> <tr> <td>Total</td> <td style="text-align:right;">197.0</td> </tr> </table>		Serie	98.0	Total	197.0																										
Serie	98.0																														
Total	197.0																														

Hold 3	Skive 10	Magnus Kristensen	
------------------	--------------------	--------------------------	--

15m	Vodskov Skytteforening	MB1	
-----	------------------------	-----	--

30.01.2015	Nordjysk mesterskab 2015	Aalborg Skyttekreds	
------------	--------------------------	---------------------	--

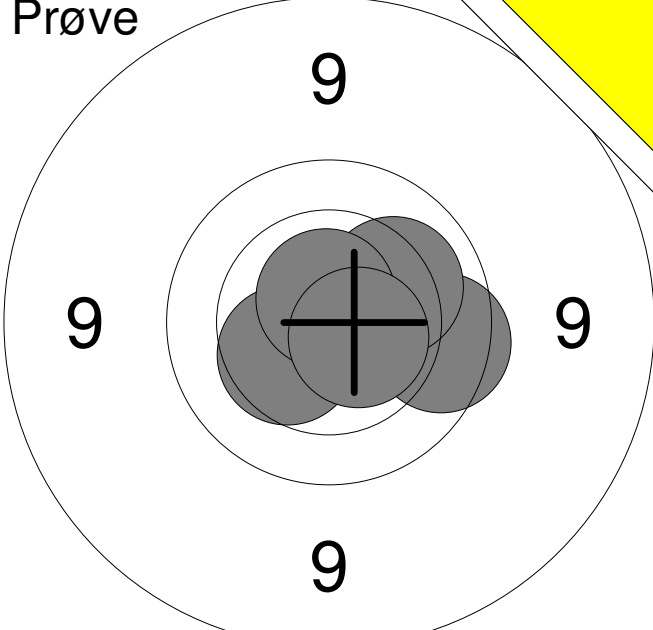
Prøve 	1: 9.8 →
	2: 10.4 ↙
	3: 10.2 →
	4: 10.7x ↑
	5: 10.6x ↘
Serie	49.0
Total	0.0

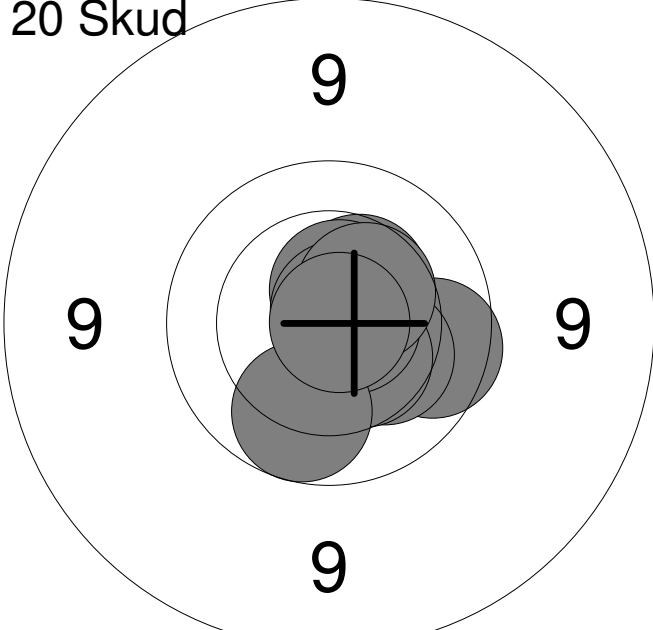
20 Skud 	1: 9.9 →
	2: 10.3 ↘
	3: 10.4 ↗
	4: 10.4 ↘
	5: 10.6x ↑
	6: 10.7x →
	7: 10.8x ↗
	8: 10.4 ↗
	9: 10.0 ↓
	10: 10.8x →
Serie	99.0
Total	99.0

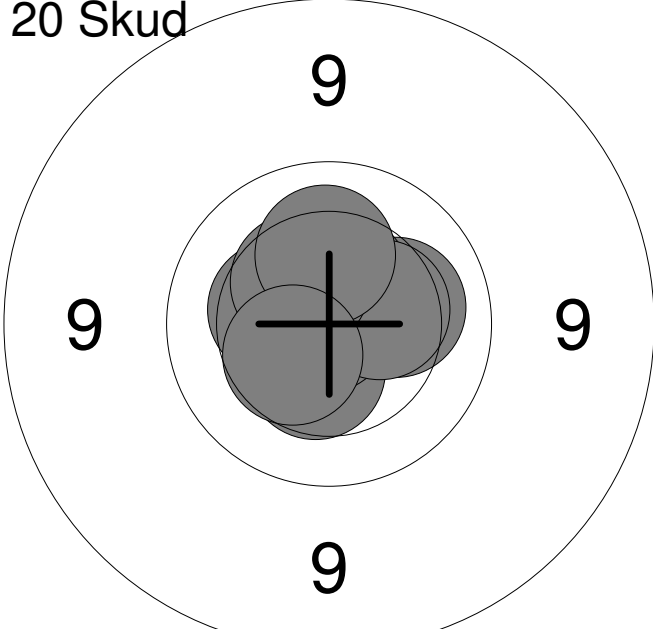
20 Skud 	11: 10.4 ↓
	12: 10.6x ↗
	13: 10.2 →
	14: 10.4 ←
	15: 10.5 ↑
	16: 10.9x ←
	17: 10.4 →
	18: 10.4 ↗
	19: 10.2 ↑
	20: 10.4 ↙
Serie	100.0
Total	199.0

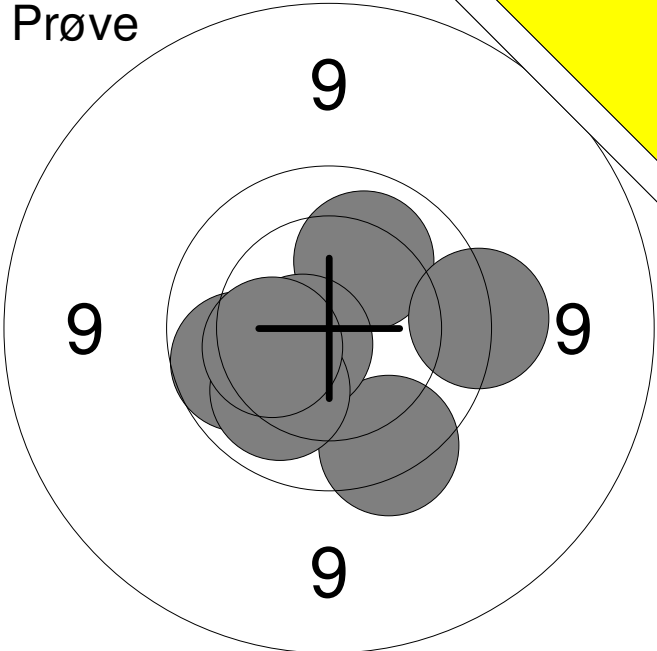
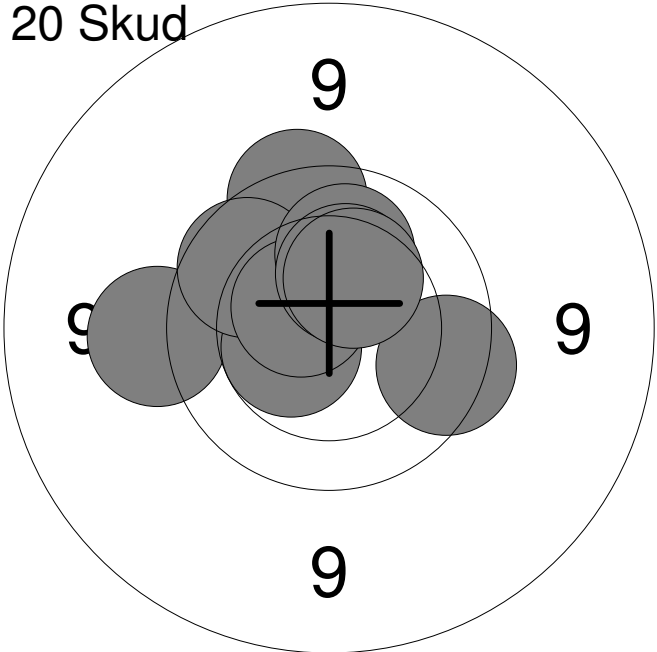
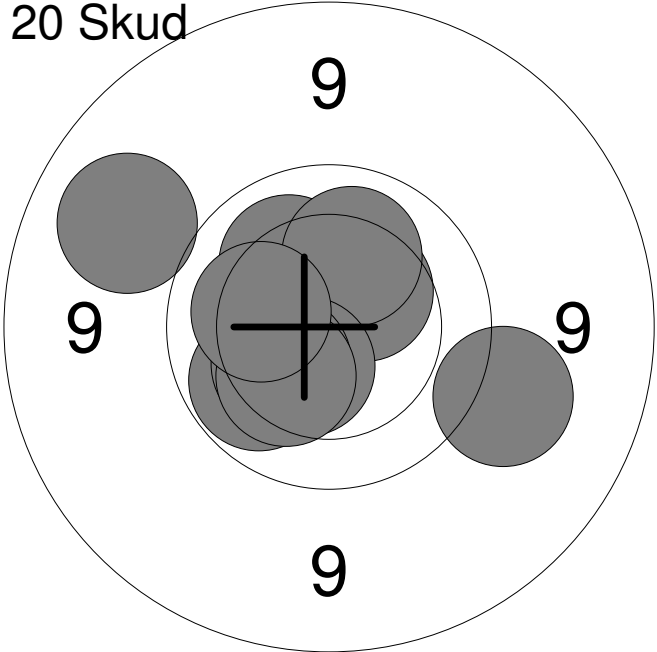
Hold	Skive	Mikkel Larsen		
3	11	Vodskov Skytteforening		MB3
15m	Nordjysk mesterskab 2015		Aalborg Skyttekreds	
30.01.2015				
Prøve		1: 9.7	↘	
		2: 9.9	↙	
		3: 10.1	↗	
		4: 10.6x	↙	
		5: 10.1	↘	
		6: 9.6	→	
		7: 10.3	↙	
		Serie	67.0	
		Total	0.0	
20 Skud		1: 10.5x	↙	
		2: 9.7	↗	
		3: 9.5	↙	
		4: 10.5	↙	
		5: 9.9	↗	
		6: 10.6x	↗	
		7: 9.8	→	
		8: 10.1	↗	
		9: 10.3	↗	
		10: 10.3	↗	
		Serie	96.0	
		Total	96.0	
20 Skud		11: 10.2	↗	
		12: 10.4	↗	
		13: 9.1	↙	
		14: 10.2	↗	
		15: 10.0	↙	
		16: 10.5	↘	
		17: 9.4	→	
		18: 10.3	↙	
		19: 10.2	↘	
		20: 10.2	↙	
		Serie	98.0	
		Total	194.0	

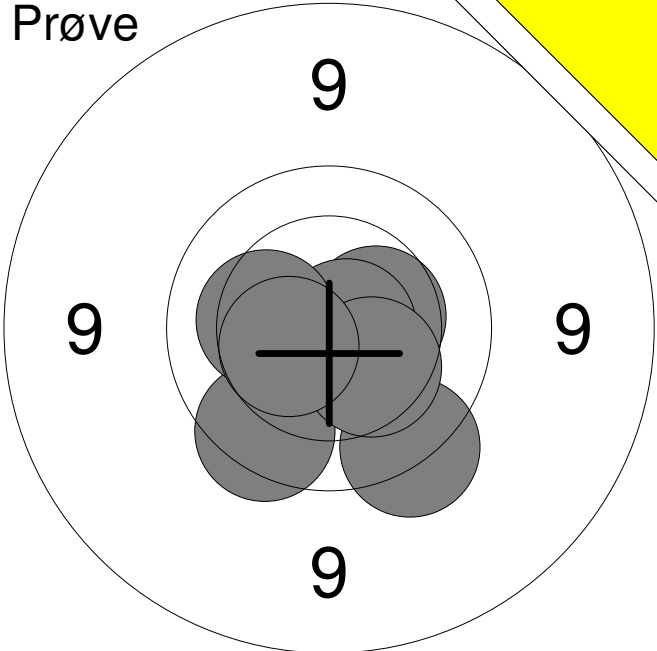
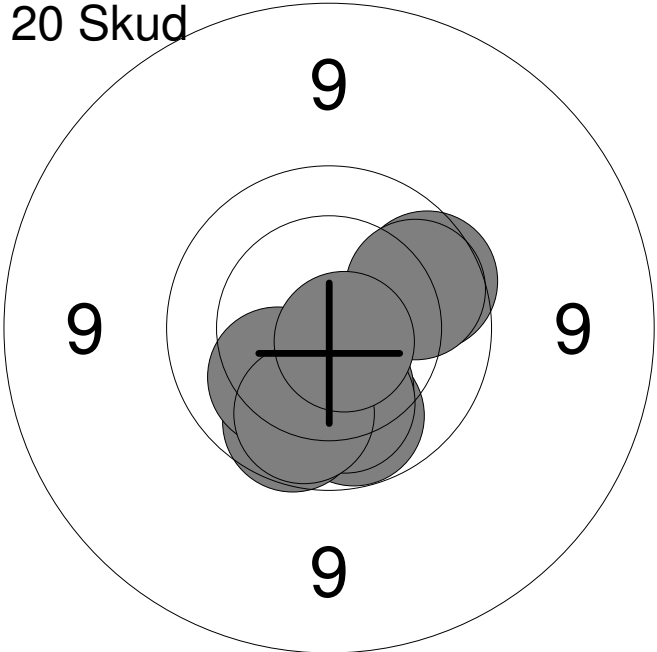
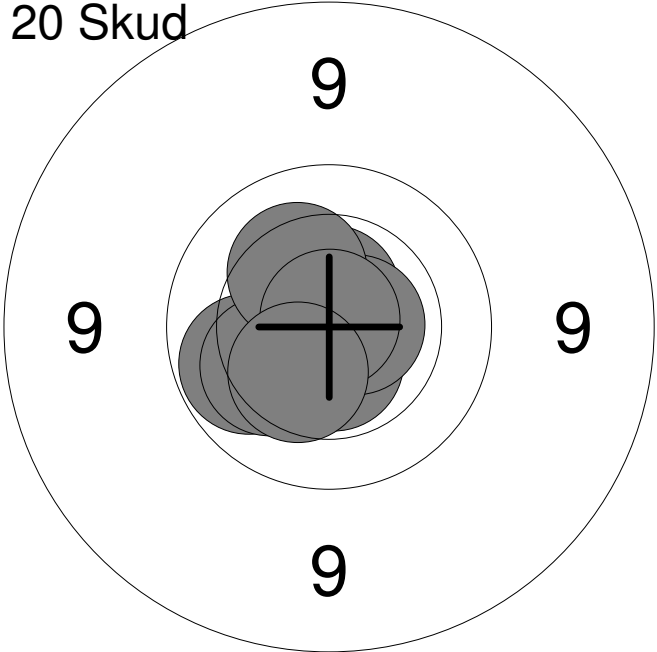
Hold	Skive	Jean Jasinski	
3	12		
15m	Aalborg Skyttekreds	MJ2	
30.01.2015	Nordjysk mesterskab 2015	Aalborg Skyttekreds	
Prøve		1: 10.4 →	
		2: 9.8 ↓	
		3: 10.8x →	
		4: 9.6 ↓	
		5: 10.3 ←	
		6: 10.3 ↓	
		7: 10.5 ←	
	Serie	68.0	
	Total	0.0	
20 Skud		1: 9.8 →	
		2: 9.9 →	
		3: 10.0 ↓	
		4: 10.3 ↓	
		5: 10.6x ↓	
		6: 10.1 ↓	
		7: 9.9 ↓	
		8: 10.2 ←	
		9: 10.0 ↓	
		10: 10.7x ↓	
	Serie	97.0	
	Total	97.0	
20 Skud		11: 10.7x ↓	
		12: 10.8x ←	
		13: 10.0 ←	
		14: 10.6x ↑	
		15: 10.2 ←	
		16: 10.6x ↓	
		17: 10.7x →	
		18: 10.3 ↗	
		19: 10.9x ↑	
		20: 10.4 ↓	
	Serie	100.0	
	Total	197.0	

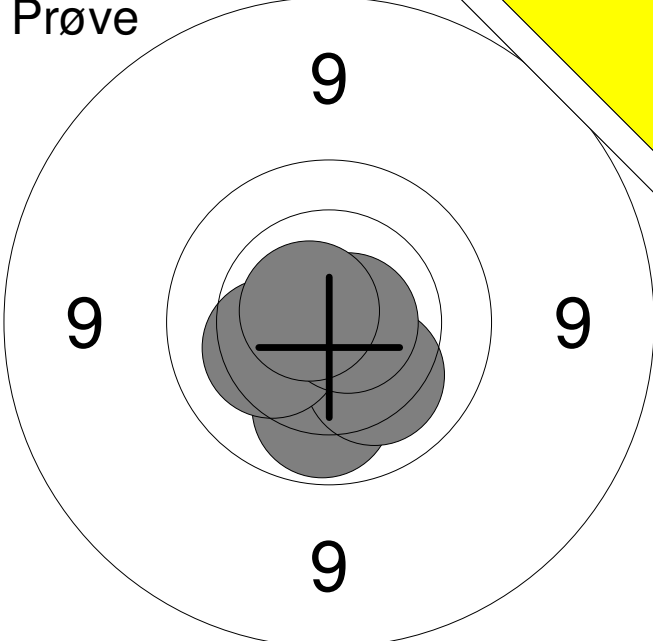
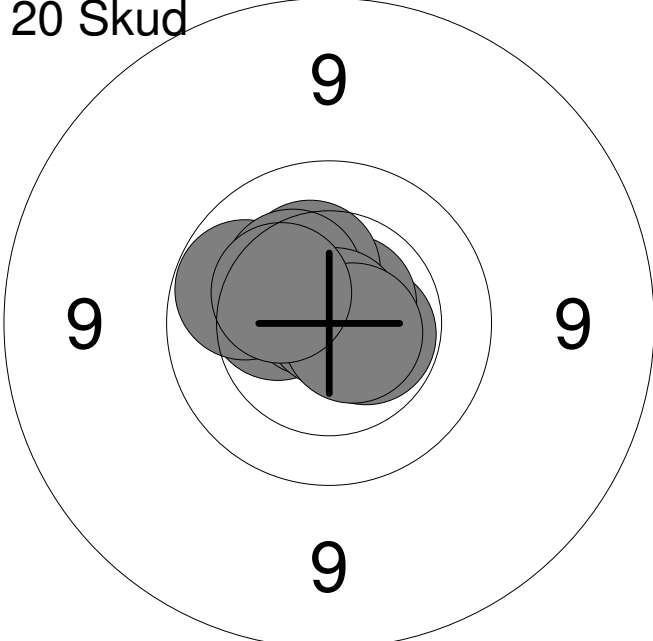
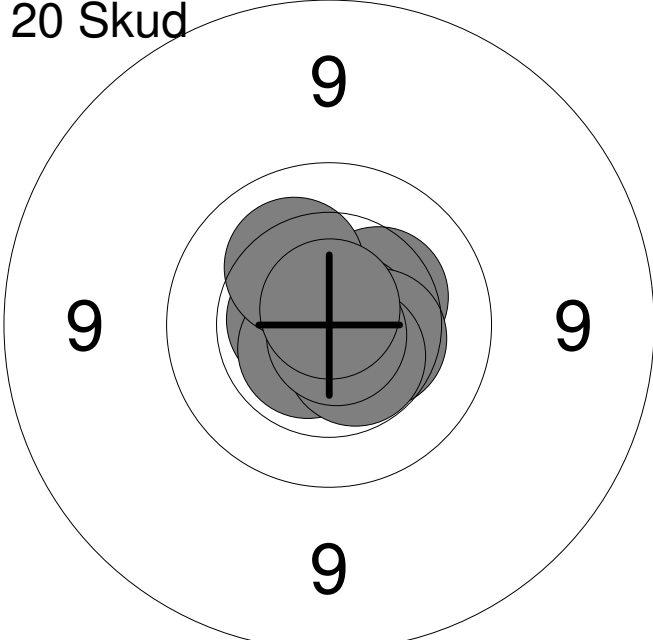
Hold	Skive	Nicklas Christensen	
4	1		
15m	Aalborg Skyttekreds	BK2	
30.01.2015	Nordjysk mesterskab 2015	Aalborg Skyttekreds	
Prøve		1: 10.0	↓
		2: 10.2	↓
		3: 10.3	←
		4: 10.7x	→
		5: 10.7x	↗
	Serie	50.0	
	Total	0.0	
20 Skud		1: 10.5x	→
		2: 10.4	←
		3: 10.7x	↗
		4: 10.3	↗
		5: 10.0	↗
		6: 10.7x	↗
		7: 10.3	↗
		8: 10.9x	↗
		9: 10.7x	→
		10: 10.3	↗
	Serie	100.0	
	Total	100.0	
20 Skud		11: 10.8x	↗
		12: 10.3	↗
		13: 10.8x	→
		14: 10.6x	←
		15: 10.4	→
		16: 10.6x	↖
		17: 10.2	↗
		18: 10.5x	↓
		19: 10.8x	↓
		20: 10.8x	↑
	Serie	100.0	
	Total	200.0	

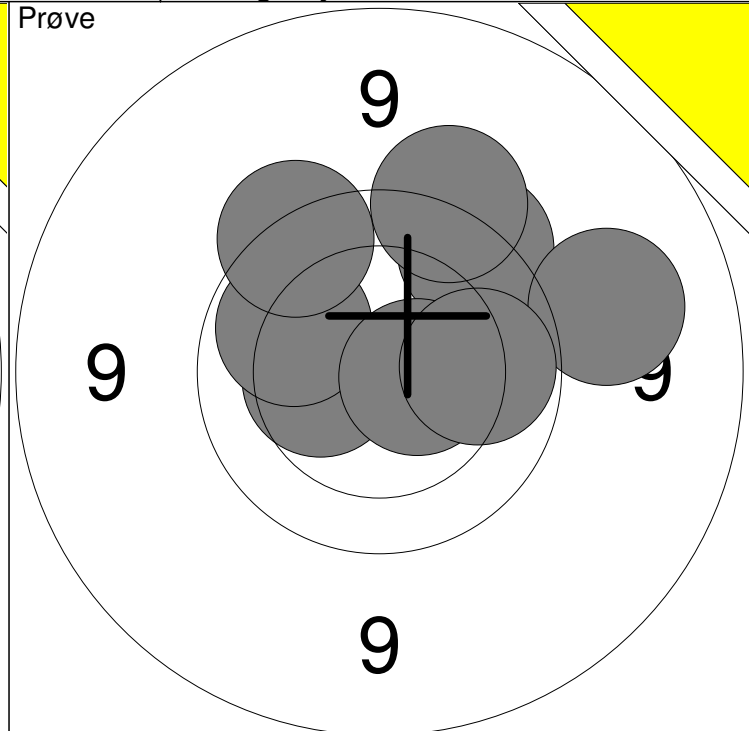
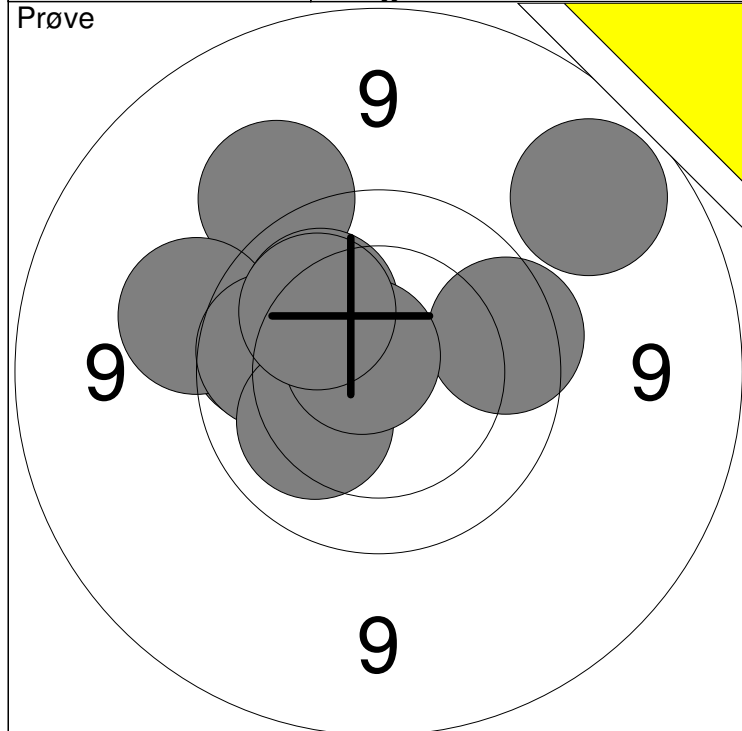

1: 9.4 ↗	6: 9.8 →	Serie	94
2: 9.9 ←	7: 10.2 ↙		
3: 9.5 ←	8: 9.0 ↗	Total	0
4: 10.1 ↗	9: 10.7x ↗		
5: 9.9 ←	10: 10.1 ↗		

11: 10.4 ←	16: 10.6x →	Serie	76
12: 10.0 ↙	17: 9.7 ↗		
13: 9.7 ↗	18: 10.0 →	Total	0
14: 9.5 ↗			
15: 9.2 →			

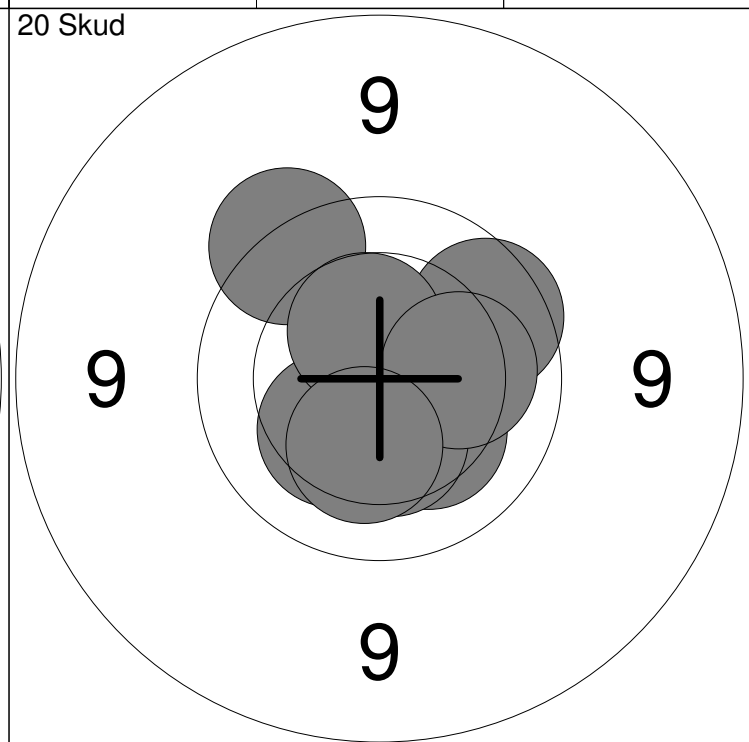
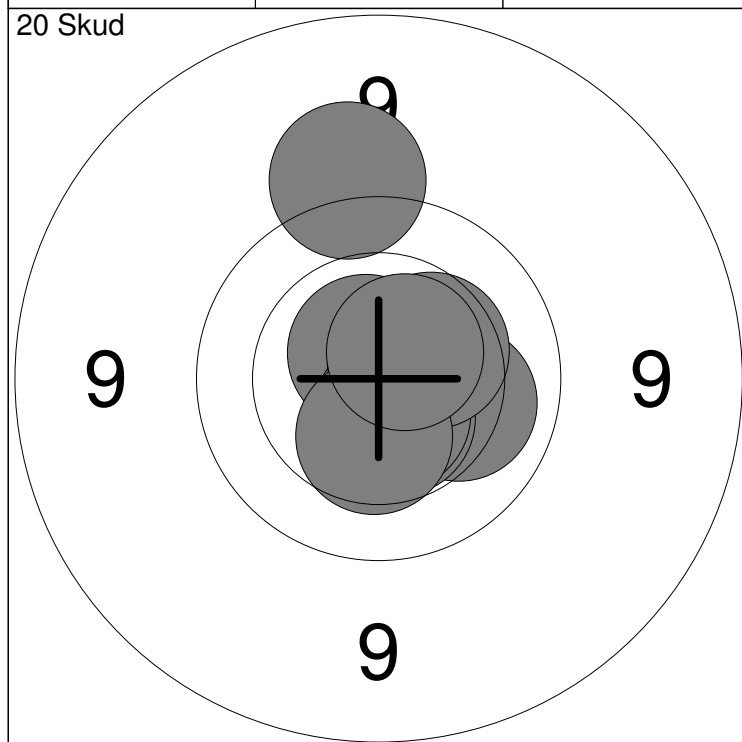

1: 10.5 →	6: 10.6x ↓	Serie	99
2: 9.4 ↑	7: 10.6x ↗		
3: 10.1 →	8: 10.4 ↗	Total	99
4: 10.7x ↗	9: 10.4 ↓		
5: 10.5x ↓	10: 10.6x ↗		

11: 10.5x ↓	16: 10.4 ↓	Serie	98
12: 10.8x ↑	17: 9.8 ↗		
13: 10.3 ↓	18: 10.5 ↑	Total	197
14: 9.6 ↗	19: 10.2 →		
15: 10.3 ↙	20: 10.3 ↓		

<p>Prøve</p>	<table style="width:100%; border-collapse: collapse;"> <tr><td style="width:10%;">1:</td><td style="width:70%;">10.7x</td><td style="width:20%; text-align: right;">→</td></tr> <tr><td>2:</td><td>10.9x</td><td style="text-align: right;">↘</td></tr> <tr><td>3:</td><td>10.2</td><td style="text-align: right;">↙</td></tr> <tr><td>4:</td><td>10.4</td><td style="text-align: right;">←</td></tr> <tr><td>5:</td><td>10.4</td><td style="text-align: right;">→</td></tr> <tr><td>6:</td><td>9.9</td><td style="text-align: right;">←</td></tr> <tr><td>7:</td><td>10.0</td><td style="text-align: right;">↑</td></tr> <tr><td>8:</td><td>10.5</td><td style="text-align: right;">←</td></tr> </table>	1:	10.7x	→	2:	10.9x	↘	3:	10.2	↙	4:	10.4	←	5:	10.4	→	6:	9.9	←	7:	10.0	↑	8:	10.5	←
1:	10.7x	→																							
2:	10.9x	↘																							
3:	10.2	↙																							
4:	10.4	←																							
5:	10.4	→																							
6:	9.9	←																							
7:	10.0	↑																							
8:	10.5	←																							
	<table style="width:100%; border-collapse: collapse;"> <tr> <td style="width:10%;">Serie</td> <td style="width:70%;"></td> <td style="width:20%; text-align: right;">79.0</td> </tr> <tr> <td>Total</td> <td></td> <td style="text-align: right;">0.0</td> </tr> </table>	Serie		79.0	Total		0.0																		
Serie		79.0																							
Total		0.0																							

<p>20 Skud</p>	<table style="width:100%; border-collapse: collapse;"> <tr><td style="width:10%;">1:</td><td style="width:70%;">9.9</td><td style="width:20%; text-align: right;">↑</td></tr> <tr><td>2:</td><td>10.5</td><td style="text-align: right;">↑</td></tr> <tr><td>3:</td><td>10.8x</td><td style="text-align: right;">→</td></tr> <tr><td>4:</td><td>10.1</td><td style="text-align: right;">↑</td></tr> <tr><td>5:</td><td>10.2</td><td style="text-align: right;">↗</td></tr> <tr><td>6:</td><td>10.7x</td><td style="text-align: right;">←</td></tr> <tr><td>7:</td><td>9.9</td><td style="text-align: right;">↗</td></tr> <tr><td>8:</td><td>10.2</td><td style="text-align: right;">←</td></tr> <tr><td>9:</td><td>10.0</td><td style="text-align: right;">↑</td></tr> <tr><td>10:</td><td>10.3</td><td style="text-align: right;">↘</td></tr> </table>	1:	9.9	↑	2:	10.5	↑	3:	10.8x	→	4:	10.1	↑	5:	10.2	↗	6:	10.7x	←	7:	9.9	↗	8:	10.2	←	9:	10.0	↑	10:	10.3	↘
1:	9.9	↑																													
2:	10.5	↑																													
3:	10.8x	→																													
4:	10.1	↑																													
5:	10.2	↗																													
6:	10.7x	←																													
7:	9.9	↗																													
8:	10.2	←																													
9:	10.0	↑																													
10:	10.3	↘																													
	<table style="width:100%; border-collapse: collapse;"> <tr> <td style="width:10%;">Serie</td> <td style="width:70%;"></td> <td style="width:20%; text-align: right;">98.0</td> </tr> <tr> <td>Total</td> <td></td> <td style="text-align: right;">98.0</td> </tr> </table>	Serie		98.0	Total		98.0																								
Serie		98.0																													
Total		98.0																													

<p>20 Skud</p>	<table style="width:100%; border-collapse: collapse;"> <tr><td style="width:10%;">11:</td><td style="width:70%;">10.5</td><td style="width:20%; text-align: right;">↘</td></tr> <tr><td>12:</td><td>10.6x</td><td style="text-align: right;">↘</td></tr> <tr><td>13:</td><td>10.6x</td><td style="text-align: right;">↗</td></tr> <tr><td>14:</td><td>10.8x</td><td style="text-align: right;">←</td></tr> <tr><td>15:</td><td>10.6x</td><td style="text-align: right;">↘</td></tr> <tr><td>16:</td><td>10.7x</td><td style="text-align: right;">↘</td></tr> <tr><td>17:</td><td>10.4</td><td style="text-align: right;">↗</td></tr> <tr><td>18:</td><td>10.6x</td><td style="text-align: right;">←</td></tr> <tr><td>19:</td><td>10.6x</td><td style="text-align: right;">↑</td></tr> <tr><td>20:</td><td>10.9x</td><td style="text-align: right;">↘</td></tr> </table>	11:	10.5	↘	12:	10.6x	↘	13:	10.6x	↗	14:	10.8x	←	15:	10.6x	↘	16:	10.7x	↘	17:	10.4	↗	18:	10.6x	←	19:	10.6x	↑	20:	10.9x	↘
11:	10.5	↘																													
12:	10.6x	↘																													
13:	10.6x	↗																													
14:	10.8x	←																													
15:	10.6x	↘																													
16:	10.7x	↘																													
17:	10.4	↗																													
18:	10.6x	←																													
19:	10.6x	↑																													
20:	10.9x	↘																													
	<table style="width:100%; border-collapse: collapse;"> <tr> <td style="width:10%;">Serie</td> <td style="width:70%;"></td> <td style="width:20%; text-align: right;">100.0</td> </tr> <tr> <td>Total</td> <td></td> <td style="text-align: right;">198.0</td> </tr> </table>	Serie		100.0	Total		198.0																								
Serie		100.0																													
Total		198.0																													

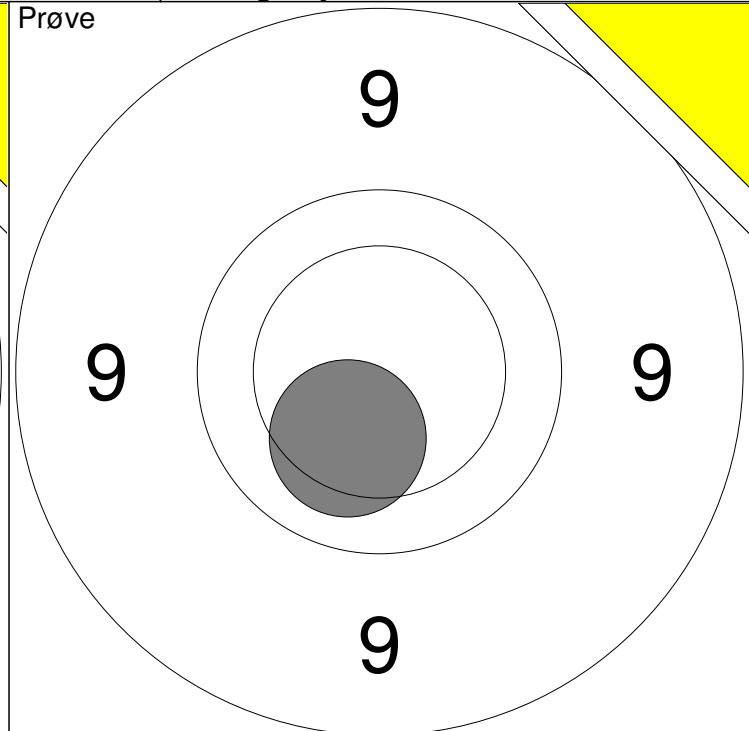
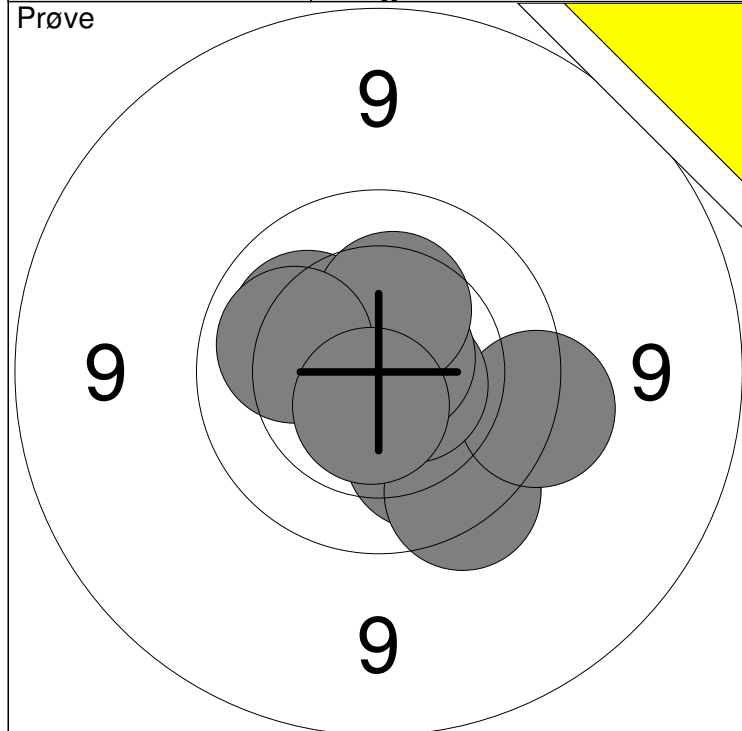

1: 9.7 ↘	6: 10.7x ↗	Serie	97
2: 10.1 ↘	7: 10.1 ↖		
3: 9.7 ↘	8: 10.3 ↑	Total	0
4: 9.6 →	9: 10.1 ←		
5: 10.6x ↘	10: 10.6x ↓		

11: 10.2 ↘	Serie	10
	Total	0

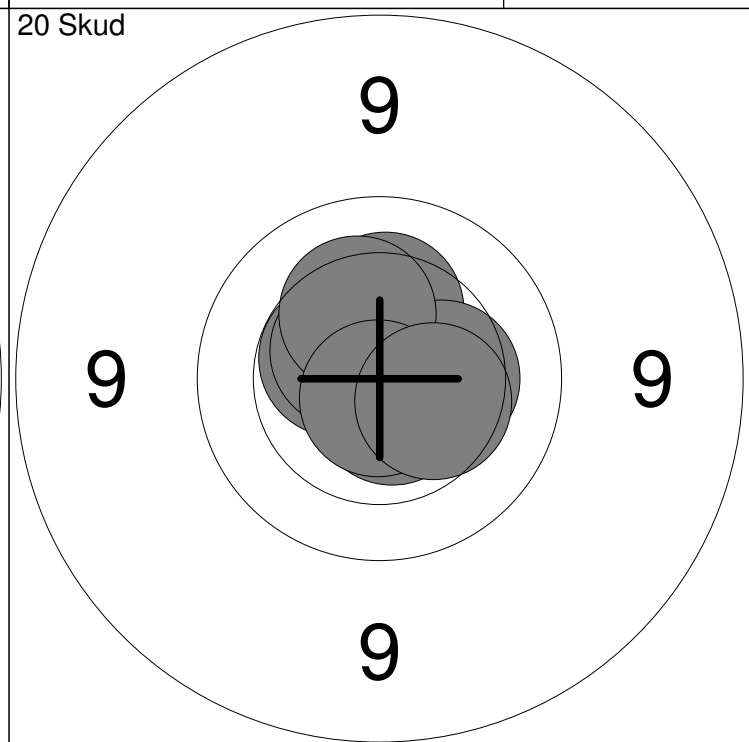
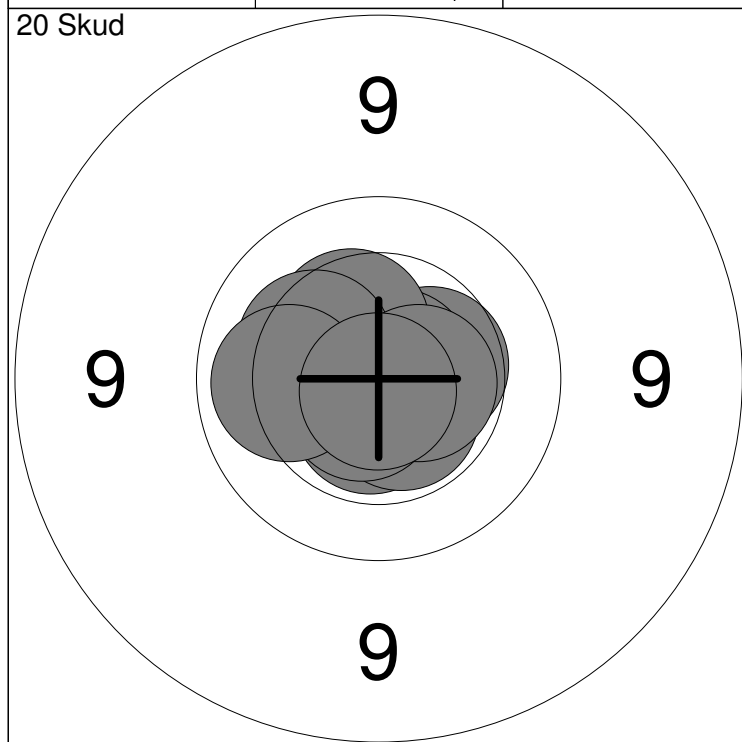

1: 10.4 →	6: 10.7x ↘	Serie	100
2: 10.6x ↓	7: 10.3 ↖		
3: 10.6x ↘	8: 10.6x →	Total	100
4: 10.8x ↗	9: 10.1 ←		
5: 10.4 ↗	10: 10.8x ↓		

11: 10.5x ↑	16: 10.7x ↓	Serie	100
12: 10.5x ↖	17: 10.4 →		
13: 10.9x →	18: 10.3 ↑	Total	200
14: 10.3 ↑	19: 10.8x ↓		
15: 10.5x ↖	20: 10.4 ↘		

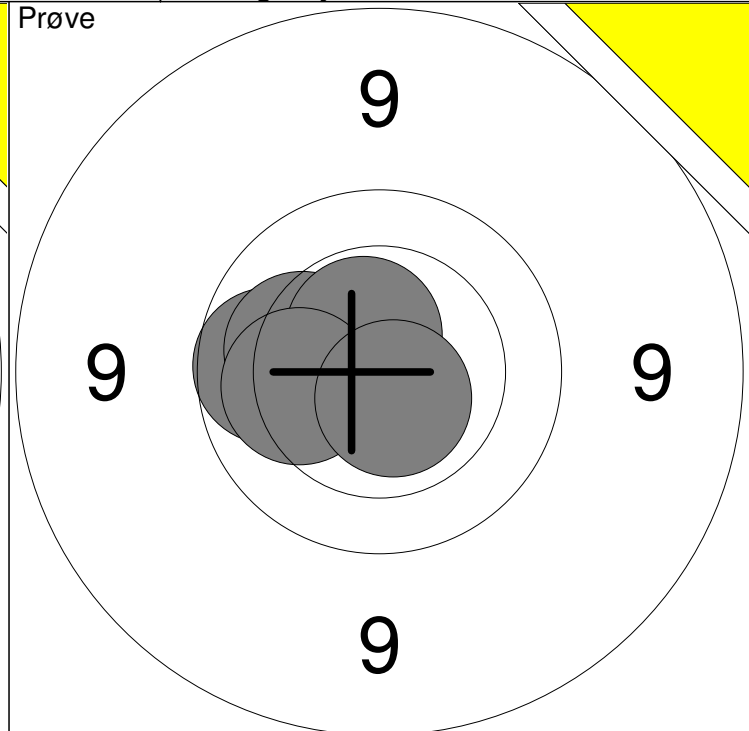
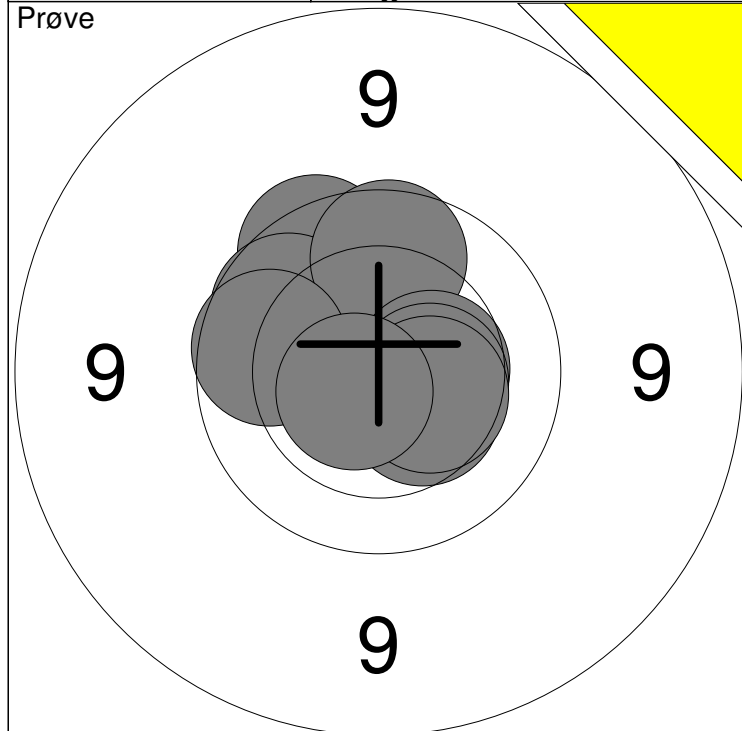

1: 9.8 ↗	6: 9.9 ←	Serie	96
2: 10.2 ↑	7: 10.4 →		
3: 9.9 ↖	8: 10.4 ↘	Total	0
4: 9.9 ↑	9: 10.4 →		
5: 10.4 →	10: 10.6x ↙		

11: 9.9 ←	Serie	49
12: 10.2 ↖		
13: 10.6x ↗	Total	0
14: 10.2 ←		
15: 10.7x ↘		

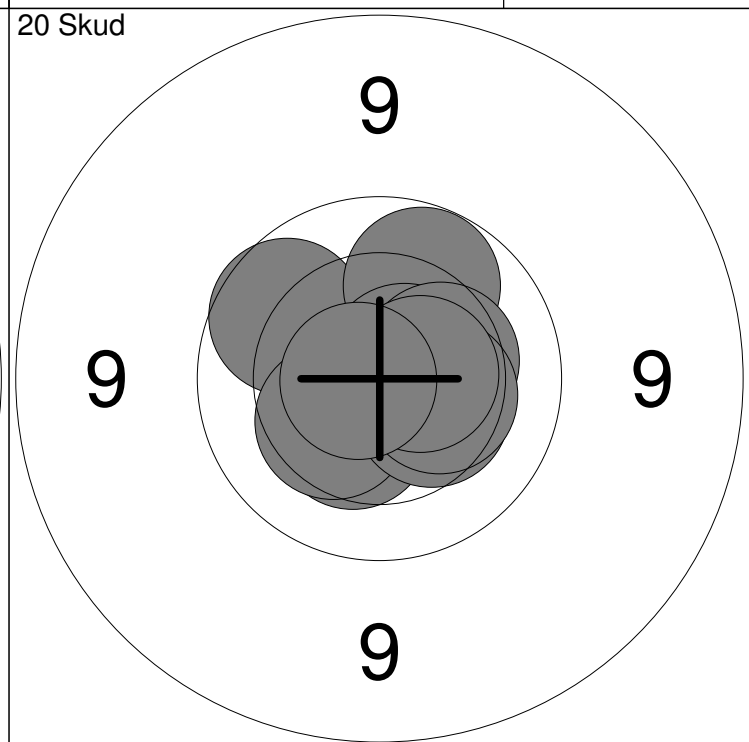
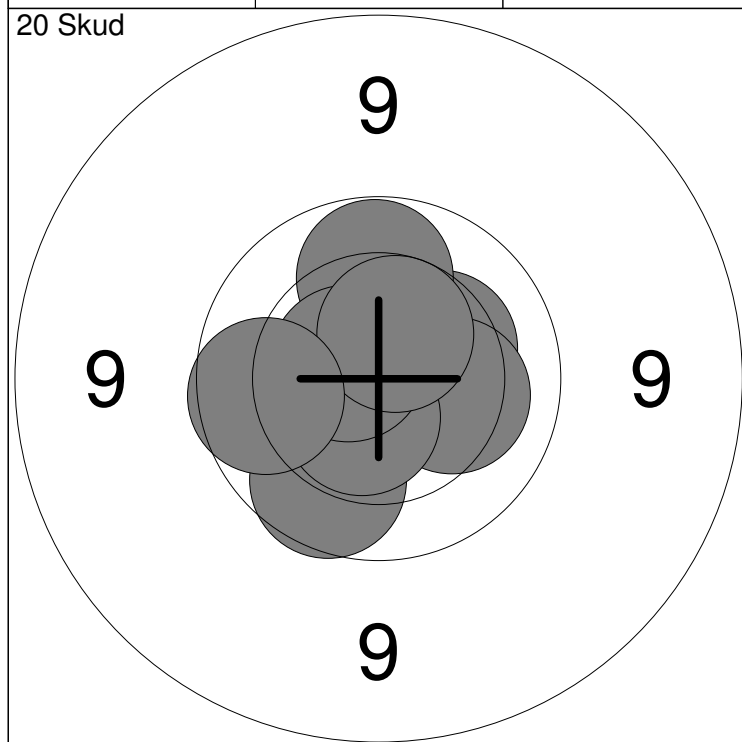

1: 10.4 ↙	6: 10.5x ↘	Serie	98
2: 10.3 →	7: 10.0 ↑		
3: 10.2 →	8: 10.6x ↖	Total	98
4: 10.7x ←	9: 10.5x ↑		
5: 9.9 ↘	10: 9.9 ←		

11: 9.9 ↖	16: 10.7x ↗	Serie	99
12: 10.4 ↘	17: 10.3 →		
13: 10.3 ↙	18: 10.4 →	Total	197
14: 10.4 ↘	19: 10.6x →		
15: 10.0 ↗	20: 10.7x ←		

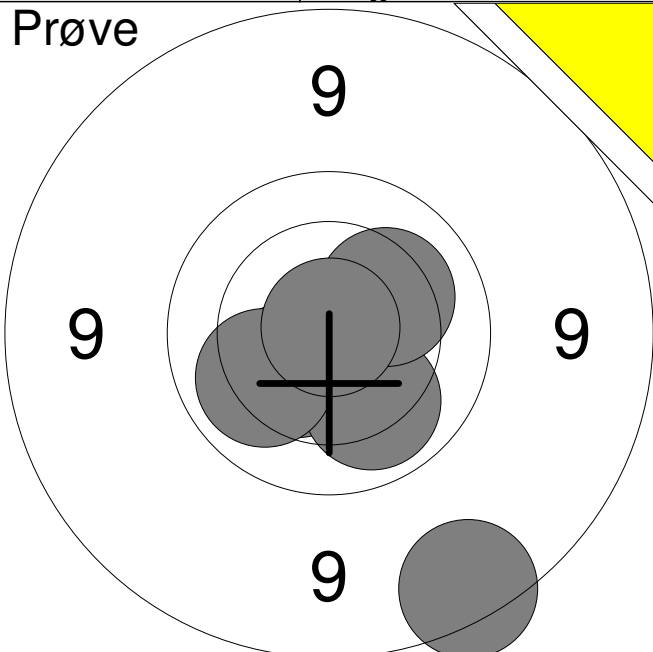
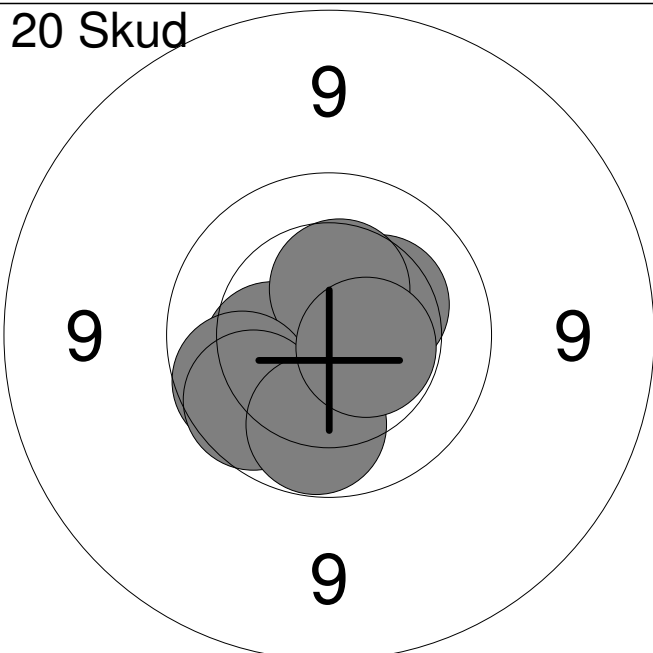
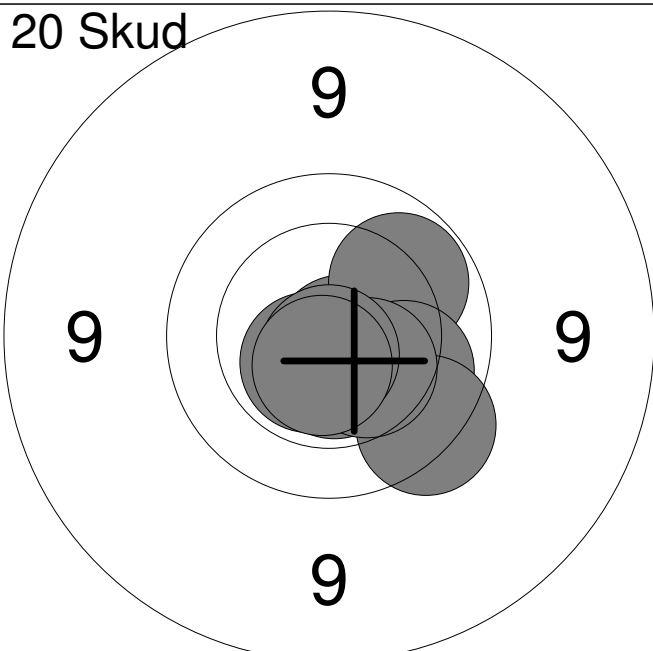
Hold	Skive	Kasper Albrechtsen	
5	1		
15m	Vester Han Herred SkytteforeningMJ2	MJ2	
30.01.2015	Nordjysk mesterskab 2015	Aalborg Skyttekreds	
Prøve		1: 8.8	↘
		2: 10.4	↙
		3: 10.1	↘
		4: 10.2	↗
		5: 10.1	↙
		6: 10.9x	↑
		Serie	58.0
		Total	0.0
20 Skud		1: 10.7x	↙
		2: 10.5x	↓
		3: 10.3	↗
		4: 10.4	↘
		5: 10.3	↙
		6: 10.4	↑
		7: 9.9	↙
		8: 9.9	↘
		9: 10.0	↓
		10: 10.5x	↗
		Serie	98.0
		Total	98.0
20 Skud		11: 10.8x	↘
		12: 10.4	↘
		13: 10.0	↗
		14: 10.6x	↘
		15: 10.1	↗
		16: 9.7	↘
		17: 10.6x	↙
		18: 10.4	↘
		19: 10.7x	↓
		20: 10.6x	↓
		Serie	99.0
		Total	197.0

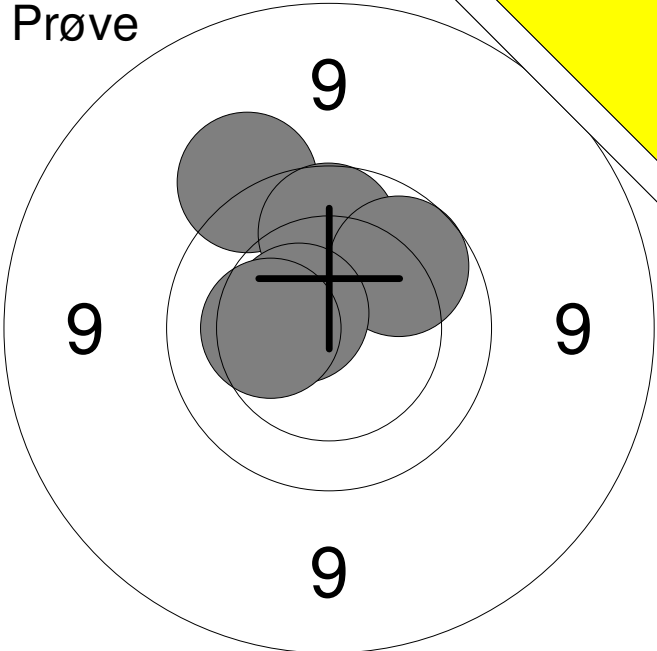
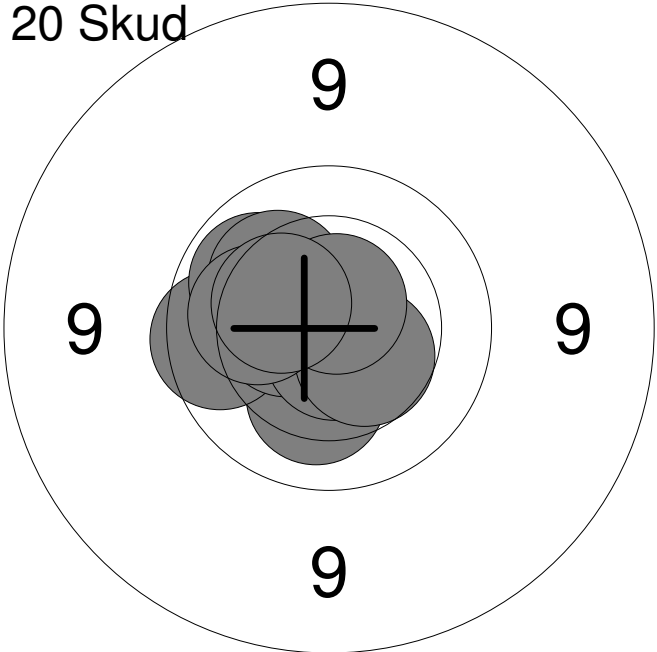
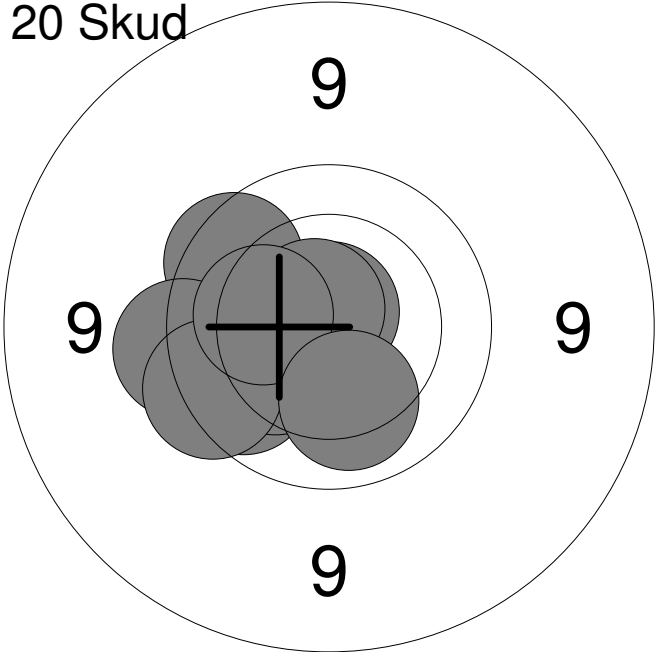
Hold	Skive	Janick G. Jensen	
5	2	15m	Vester Han Herred Skytteforening MB2 MB2
30.01.2015	Nordjysk mesterskab 2015	Aalborg Skyttekreds	
Prøve		1: 9.5 ↖	
		2: 9.9 ↑	
		3: 9.9 ↗	
		4: 10.6x ↖	
		5: 10.3 ←	
	Serie	47.0	
	Total	0.0	
20 Skud		1: 10.2 ↓	
		2: 9.8 ←	
		3: 10.0 ↗	
		4: 10.5x ←	
		5: 10.2 ↗	
		6: 10.7x ↓	
		7: 10.5 ↓	
		8: 10.2 ←	
		9: 10.7x ↑	
		10: 10.4 ↖	
	Serie	99.0	
	Total	99.0	
20 Skud		11: 9.8 ↖	
		12: 10.1 ←	
		13: 10.8x ↑	
		14: 9.9 ↖	
		15: 10.2 ↖	
		16: 10.7x ↗	
		17: 9.6 ←	
		18: 9.7 ↖	
		19: 10.2 ←	
		20: 10.1 ↓	
	Serie	96.0	
	Total	195.0	

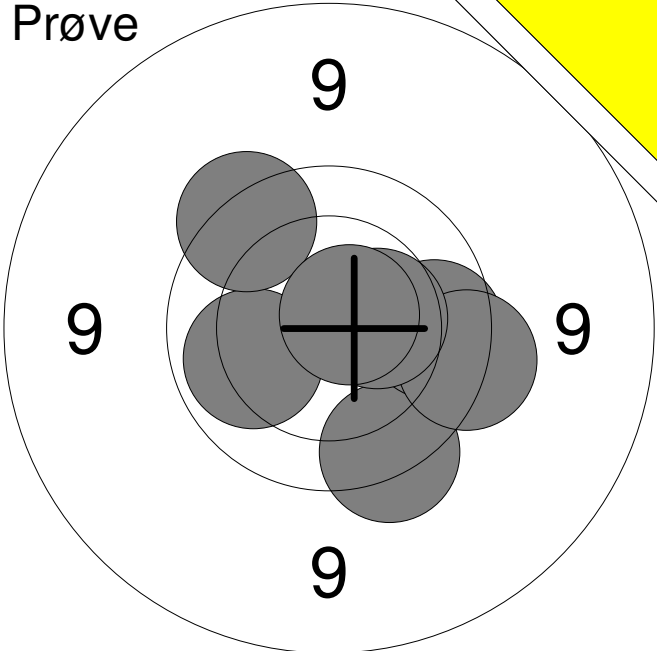
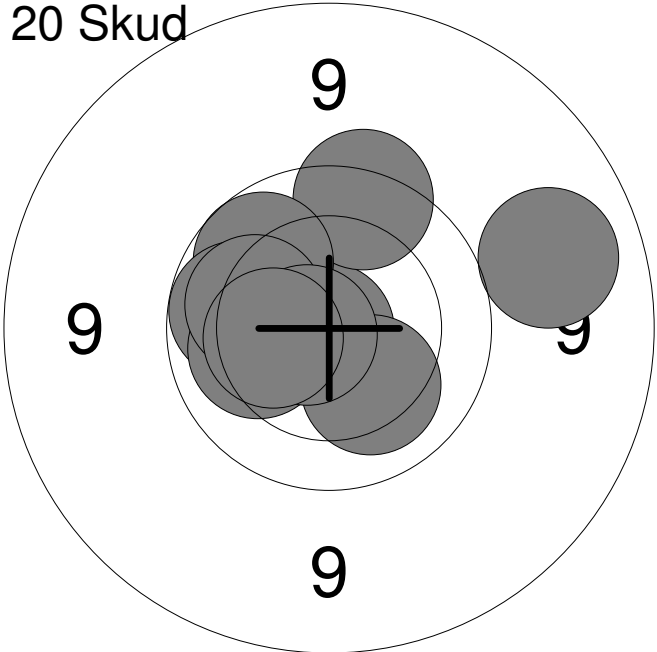
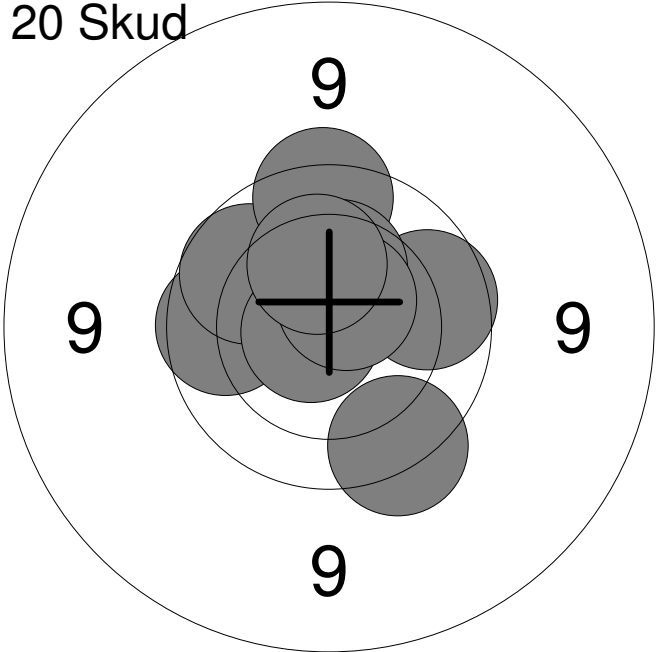
Hold	Skive	Lea Larsen	
5	3	15m	Vester Han Herred Skytteforening MB2 MB2
30.01.2015	Nordjysk mesterskab 2015	Aalborg Skyttekreds	
Prøve 	1:	9.7	↘
	2:	9.9	→
	3:	10.1	↙
	4:	9.7	→
	5:	9.7	↗
	6:	10.4	→
	7:	10.7x	↗
	Serie	66.0	
	Total	0.0	
20 Skud 	1:	10.9x	↙
	2:	9.7	↑
	3:	9.9	↗
	4:	10.0	↖
	5:	10.1	↖
	6:	10.2	↘
	7:	10.1	↖
	8:	9.1	→
	9:	10.7x	↖
	10:	10.3	↖
	Serie	97.0	
	Total	97.0	
20 Skud 	11:	10.1	↗
	12:	9.9	↖
	13:	9.9	↗
	14:	9.7	↘
	15:	9.9	→
	16:	9.7	↑
	17:	10.3	↑
	18:	10.7x	↖
	19:	10.6x	↗
	20:	10.3	↑
	Serie	95.0	
	Total	192.0	

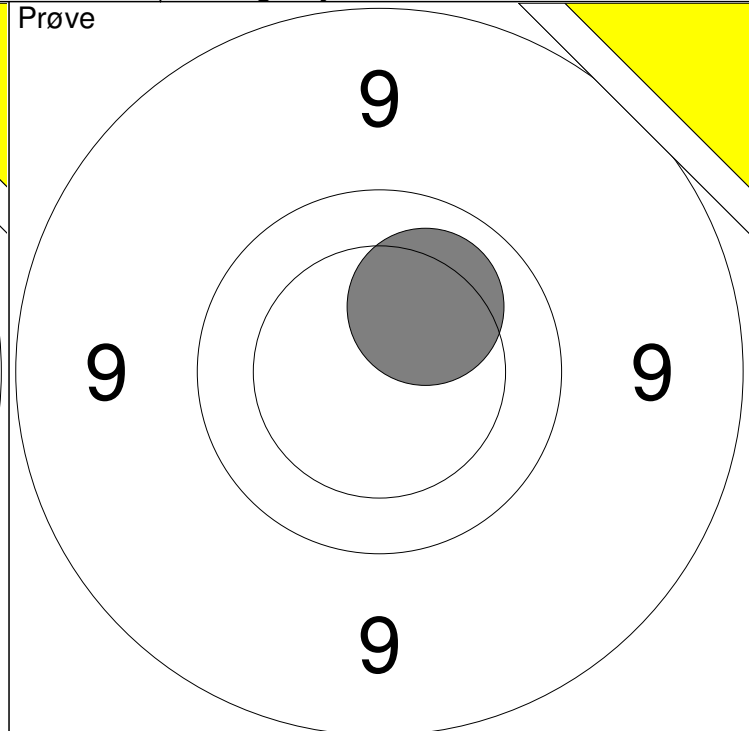
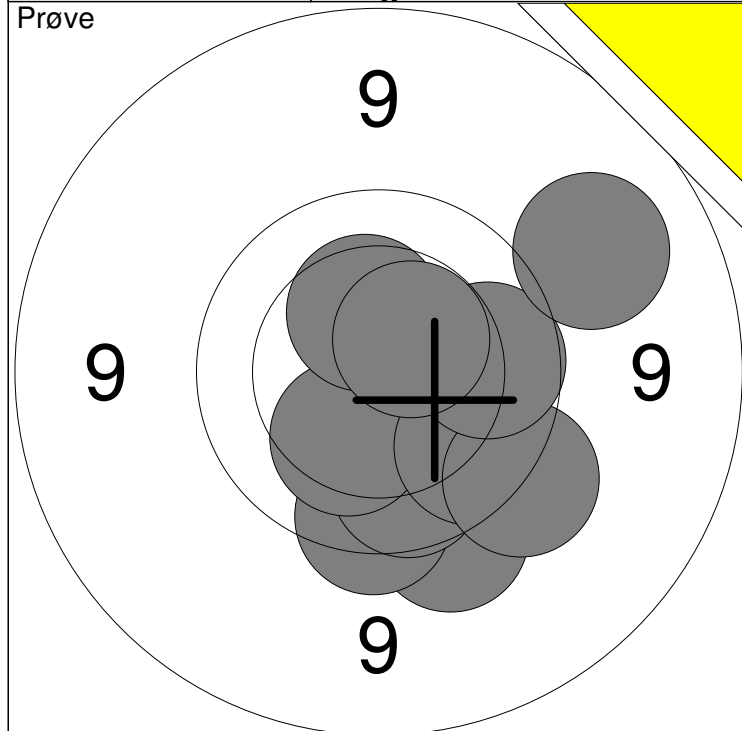

1: 9.5 ↓	6: 9.5 ↓	Serie	93
2: 9.7 ↓	7: 10.4 ↑		
3: 9.9 ↓	8: 9.9 →	Total	0
4: 10.2 ↓	9: 9.2 ↗		
5: 9.9 ↓	10: 10.5x ↗		

11: 10.2 ↗	Serie	10
	Total	0

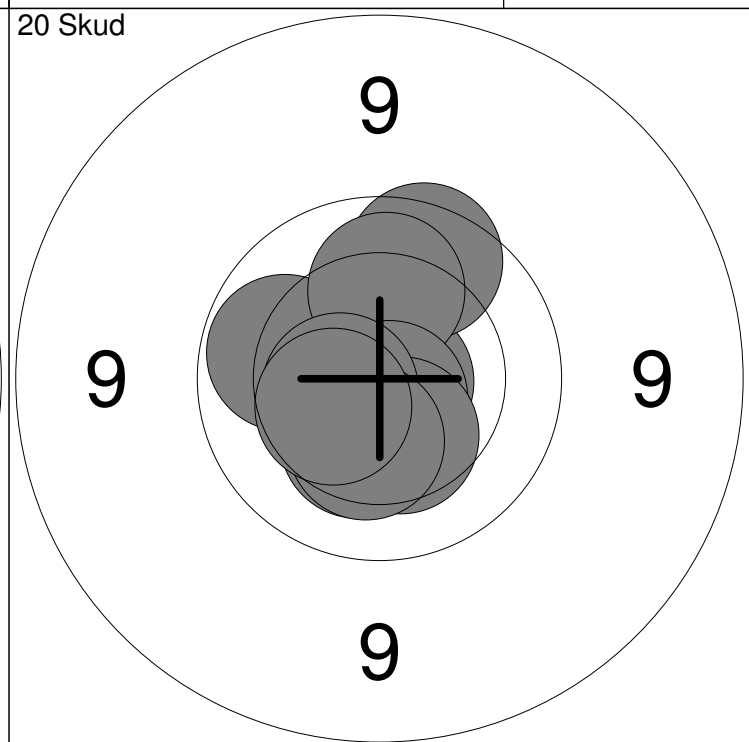
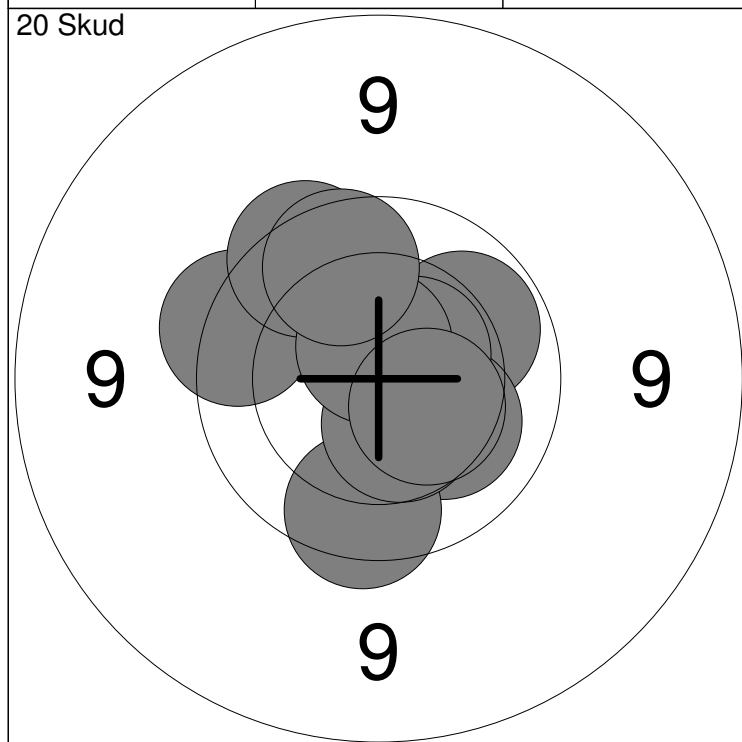

1: 10.0 ↗	6: 9.7 ↗	Serie	96
2: 10.2 ↘	7: 10.5 ↓		
3: 10.6x ↗	8: 10.6x ↑	Total	96
4: 9.8 ↓	9: 9.9 ↑		
5: 9.7 ←	10: 10.4 ↘		

11: 10.8x →	16: 10.7x ↓	Serie	99
12: 9.8 ↑	17: 10.4 ↓		
13: 10.3 ↓	18: 10.6x ←	Total	195
14: 10.0 ←	19: 10.3 ↓		
15: 10.1 ↑	20: 10.4 ←		

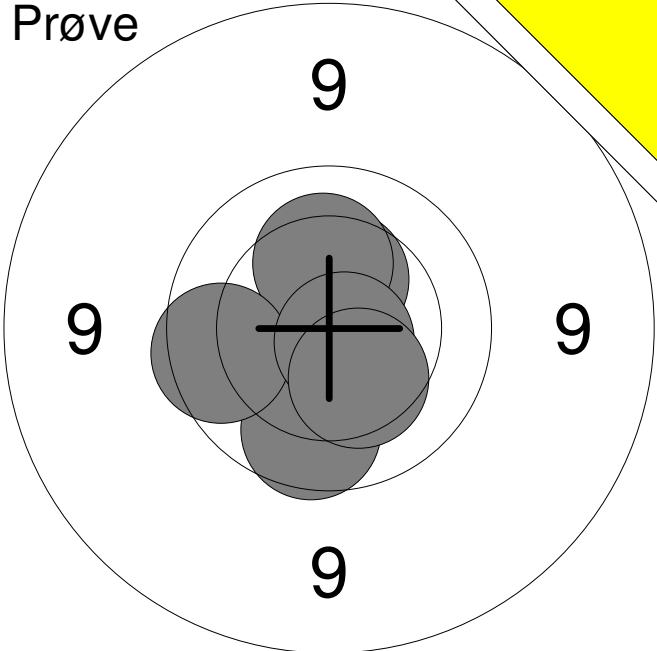
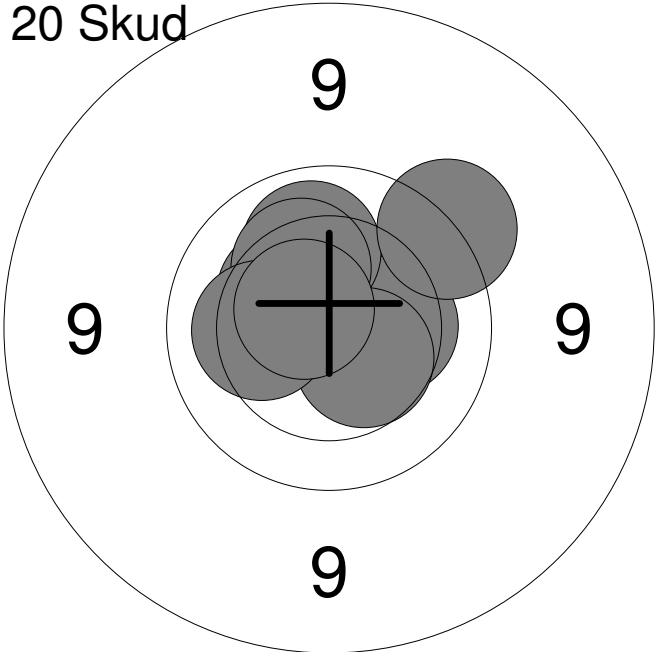
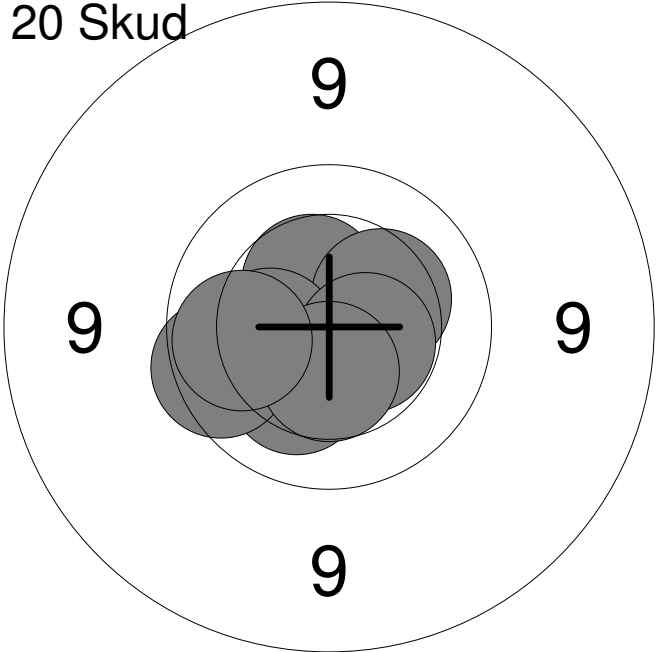
Hold	Skive	Jonas N. Rasmussen	
5	6	15m	Skf. Kimbrene MJ2
30.01.2015	Nordjysk mesterskab 2015	Aalborg Skyttekreds	
Prøve		1: 10.5x ↙	
		2: 10.6x ↓	
		3: 10.4 ↑	
		4: 10.2 ↑	
		5: 9.9 ↓	
		6: 9.8 ←	
		7: 10.7x ↘	
		8: 10.3 ↓	
	Serie	78.0	
	Total	0.0	
20 Skud		1: 10.6x →	
		2: 10.4 ↖	
		3: 10.6x ↑	
		4: 10.3 →	
		5: 10.1 ↑	
		6: 10.5 ↘	
		7: 9.6 ↗	
		8: 10.2 ↑	
		9: 10.2 ←	
		10: 10.6x ↗	
	Serie	99.0	
	Total	99.0	
20 Skud		11: 10.8x ↓	
		12: 10.4 →	
		13: 10.5 ↑	
		14: 10.2 ↓	
		15: 10.3 ↗	
		16: 10.3 ←	
		17: 9.8 ←	
		18: 10.5x ↘	
		19: 10.5 ↓	
		20: 10.0 ←	
	Serie	99.0	
	Total	198.0	

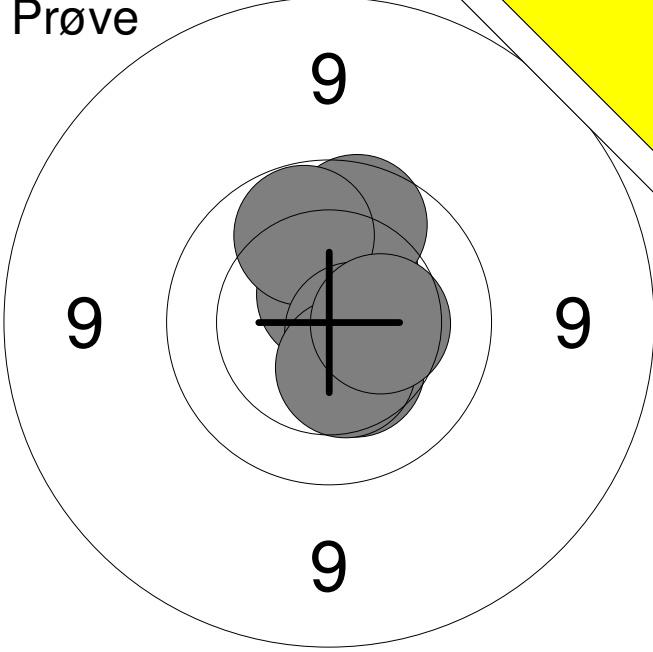
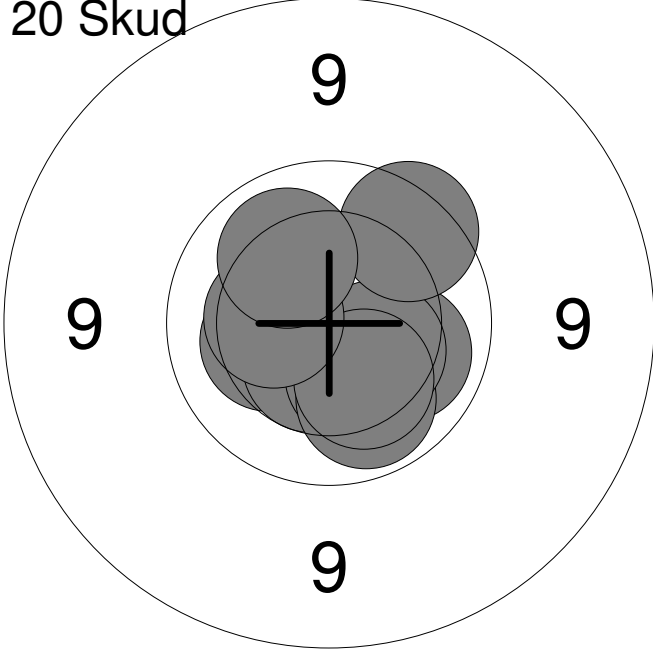
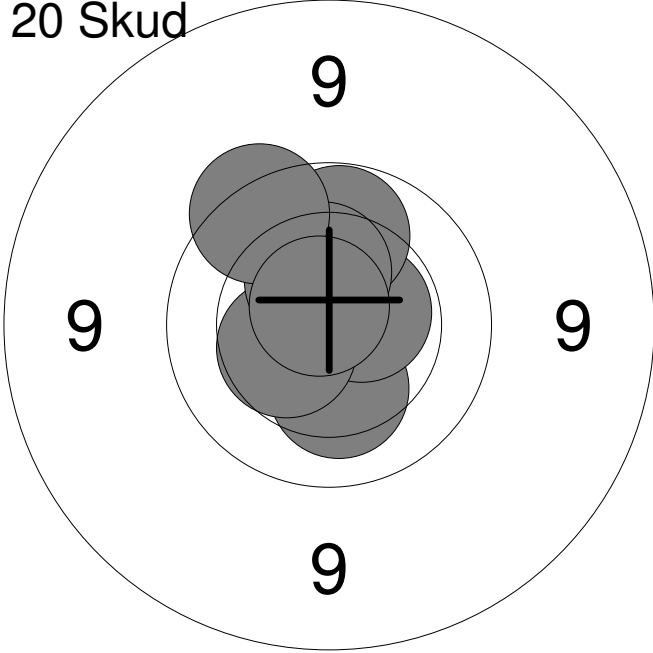
Hold	Skive	Frederik Wasard Thomsen		
5	12	15m	Skf. Kimbrene MJ2	
30.01.2015	Nordjysk mesterskab 2015	Aalborg Skyttekreds		
Prøve 	1:	10.4	↗	
	2:	10.6x	↑	
	3:	9.9	↑	
	4:	10.0	↑	
	5:	10.4	↘	
	6:	10.7x	↘	
	7:	10.4	↘	
	8:	10.4	→	
	Serie		79.0	
	Total		0.0	
20 Skud 	1:	10.3	←	
	2:	10.5	↘	
	3:	10.1	→	
	4:	10.3	↘	
	5:	10.0	↘	
	6:	10.4	↘	
	7:	10.2	↘	
	8:	9.8	↗	
	9:	10.4	←	
	10:	10.1	↗	
Serie		99.0		
Total		99.0		
20 Skud 	11:	10.3	↘	
	12:	10.0	↑	
	13:	10.6x	→	
	14:	10.0	↑	
	15:	10.0	↑	
	16:	10.4	←	
	17:	10.4	↑	
	18:	10.4	↑	
	19:	9.7	↗	
	20:	10.7x	↗	
Serie		99.0		
Total		198.0		

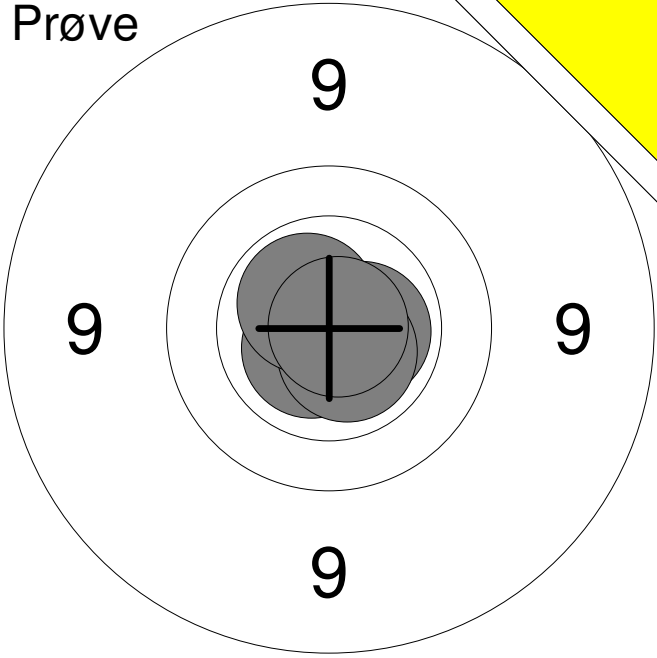
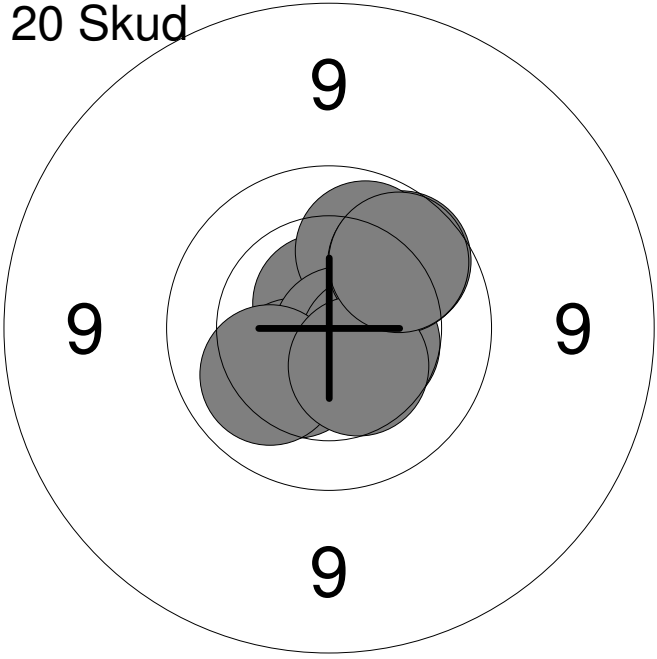
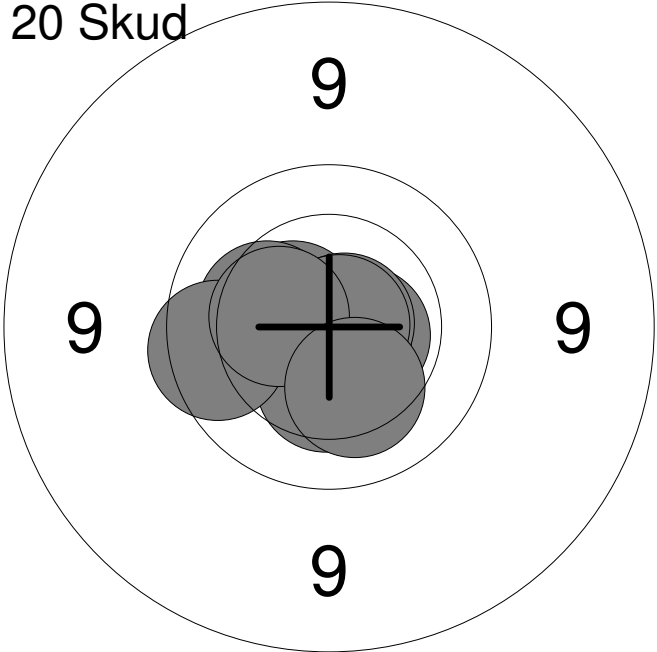
Hold	Skive	Nicklas Christensen	
6	1		
15m	Aalborg Skyttekreds	MB2	
30.01.2015	Nordjysk mesterskab 2015	Aalborg Skyttekreds	
Prøve		1: 10.6x →	
		2: 10.7x ↘	
		3: 10.6x ↘	
		4: 10.6x ↗	
		5: 10.9x →	
		Serie	50.0
		Total	0.0
20 Skud		1: 10.7x ↑	
		2: 9.9 ↗	
		3: 10.4 ↘	
		4: 10.0 ↗	
		5: 10.8x ↘	
		6: 10.5 ↘	
		7: 10.1 ↘	
		8: 9.9 ↗	
		9: 10.4 ↘	
		10: 9.9 ↗	
		Serie	97.0
		Total	97.0
20 Skud		11: 10.4 ↓	
		12: 10.6x →	
		13: 10.5x ↗	
		14: 10.8x ↘	
		15: 10.8x →	
		16: 10.8x →	
		17: 10.3 ←	
		18: 9.8 ←	
		19: 10.4 ←	
		20: 10.2 ↓	
		Serie	99.0
		Total	196.0

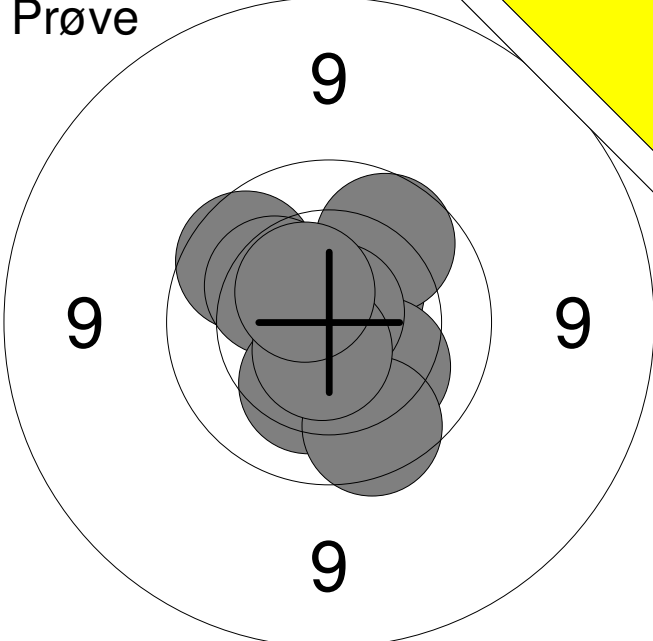
Prøve 	1:	9.9	↗
	2:	10.5x	↗
	3:	9.9	↗
	4:	10.2	↘
	5:	10.2	↗
	6:	10.3	↘
	7:	10.8x	↗
	8:	9.8	↘
	9:	10.6x	↘
	10:	10.5x	↗
	Serie		97.0
Total		0.0	

20 Skud 	1:	9.9	↙
	2:	10.4	→
	3:	10.9x	↗
	4:	10.2	↘
	5:	10.5	←
	6:	9.9	↘
	7:	10.5x	↘
	8:	10.6x	↘
	9:	10.6x	↗
	10:	9.9	↘
	Serie		97.0
Total		97.0	

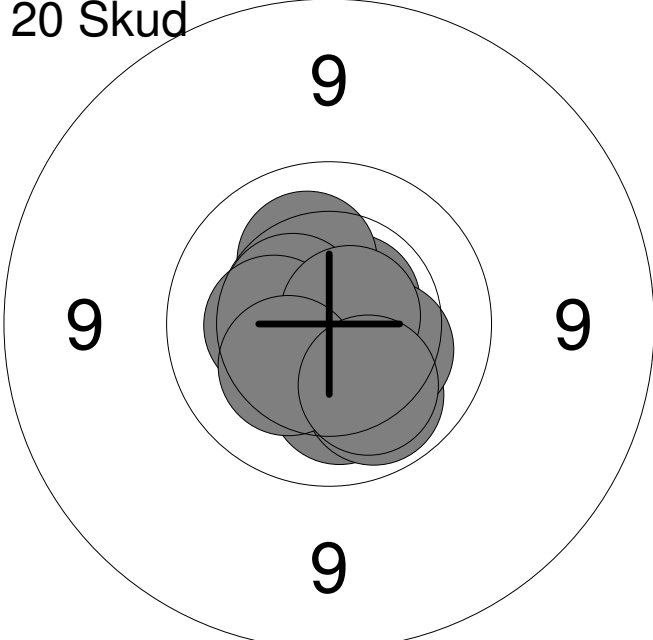
20 Skud 	11:	10.2	↘
	12:	10.0	↘
	13:	10.6x	↗
	14:	10.2	↗
	15:	10.3	↘
	16:	10.5x	↗
	17:	10.3	←
	18:	10.7x	→
	19:	10.3	↙
	20:	10.2	↘
	Serie		100.0
Total		197.0	

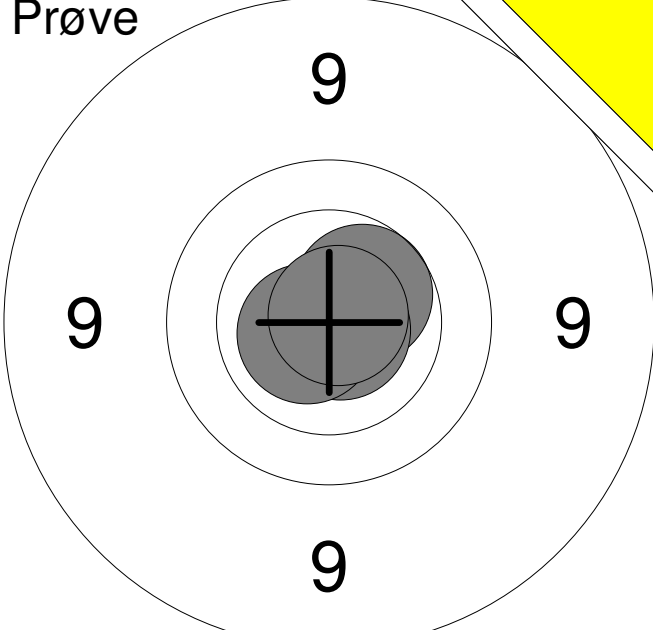
<p>Prøve</p> 	<table style="width:100%; border-collapse: collapse;"> <tr><td style="width:10%;">1:</td><td style="width:70%;">10.9x</td><td style="width:20%; text-align: right;">↓</td></tr> <tr><td>2:</td><td>10.5</td><td style="text-align: right;">↗</td></tr> <tr><td>3:</td><td>10.8x</td><td style="text-align: right;">↘</td></tr> <tr><td>4:</td><td>10.7x</td><td style="text-align: right;">↙</td></tr> <tr><td>5:</td><td>10.8x</td><td style="text-align: right;">↗</td></tr> </table>	1:	10.9x	↓	2:	10.5	↗	3:	10.8x	↘	4:	10.7x	↙	5:	10.8x	↗
1:	10.9x	↓														
2:	10.5	↗														
3:	10.8x	↘														
4:	10.7x	↙														
5:	10.8x	↗														
<table style="width:100%; border-collapse: collapse;"> <tr> <td style="width:80%;">Serie</td> <td style="text-align: right;">50.0</td> </tr> <tr> <td>Total</td> <td style="text-align: right;">0.0</td> </tr> </table>		Serie	50.0	Total	0.0											
Serie	50.0															
Total	0.0															

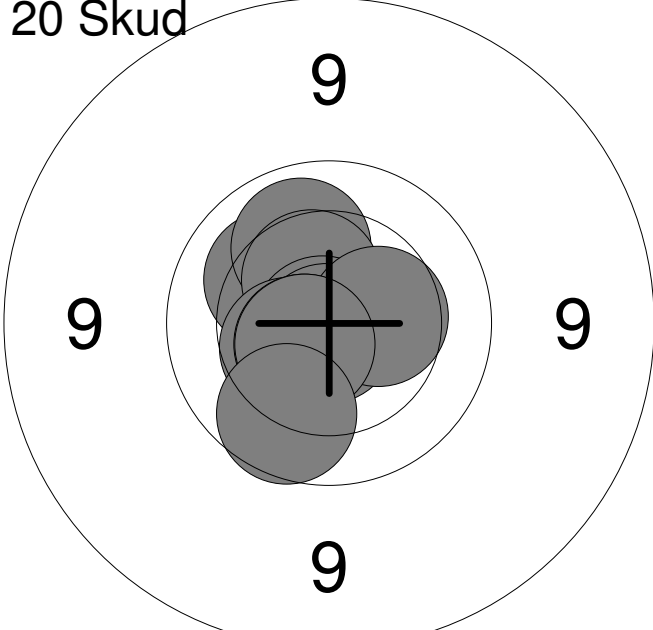
<p>20 Skud</p> 	<table style="width:100%; border-collapse: collapse;"> <tr><td style="width:10%;">1:</td><td style="width:70%;">10.2</td><td style="width:20%; text-align: right;">↖</td></tr> <tr><td>2:</td><td>10.1</td><td style="text-align: right;">↑</td></tr> <tr><td>3:</td><td>10.4</td><td style="text-align: right;">↑</td></tr> <tr><td>4:</td><td>10.9x</td><td style="text-align: right;">↙</td></tr> <tr><td>5:</td><td>10.8x</td><td style="text-align: right;">↓</td></tr> <tr><td>6:</td><td>10.4</td><td style="text-align: right;">↙</td></tr> <tr><td>7:</td><td>10.4</td><td style="text-align: right;">→</td></tr> <tr><td>8:</td><td>10.6x</td><td style="text-align: right;">↙</td></tr> <tr><td>9:</td><td>10.6x</td><td style="text-align: right;">↙</td></tr> <tr><td>10:</td><td>9.9</td><td style="text-align: right;">↓</td></tr> </table>	1:	10.2	↖	2:	10.1	↑	3:	10.4	↑	4:	10.9x	↙	5:	10.8x	↓	6:	10.4	↙	7:	10.4	→	8:	10.6x	↙	9:	10.6x	↙	10:	9.9	↓
1:	10.2	↖																													
2:	10.1	↑																													
3:	10.4	↑																													
4:	10.9x	↙																													
5:	10.8x	↓																													
6:	10.4	↙																													
7:	10.4	→																													
8:	10.6x	↙																													
9:	10.6x	↙																													
10:	9.9	↓																													
<table style="width:100%; border-collapse: collapse;"> <tr> <td style="width:80%;">Serie</td> <td style="text-align: right;">99.0</td> </tr> <tr> <td>Total</td> <td style="text-align: right;">99.0</td> </tr> </table>		Serie	99.0	Total	99.0																										
Serie	99.0																														
Total	99.0																														

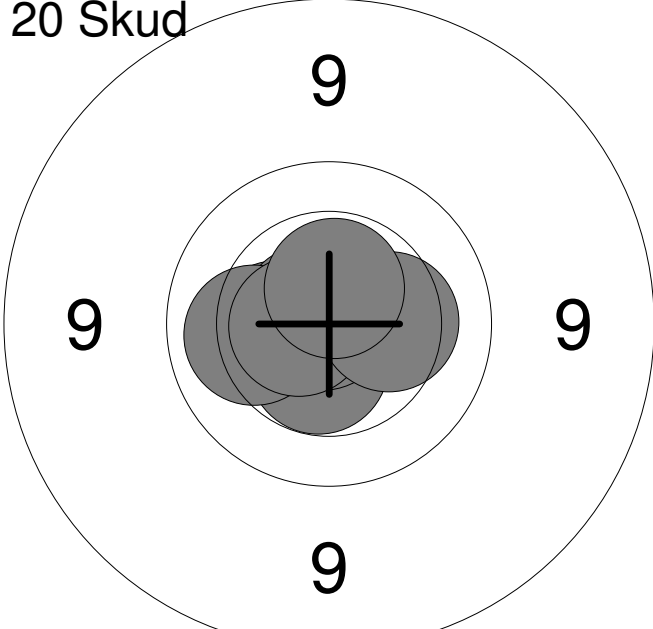
<p>20 Skud</p> 	<table style="width:100%; border-collapse: collapse;"> <tr><td style="width:10%;">11:</td><td style="width:70%;">10.4</td><td style="width:20%; text-align: right;">↙</td></tr> <tr><td>12:</td><td>10.8x</td><td style="text-align: right;">↑</td></tr> <tr><td>13:</td><td>10.7x</td><td style="text-align: right;">↙</td></tr> <tr><td>14:</td><td>10.5x</td><td style="text-align: right;">↓</td></tr> <tr><td>15:</td><td>10.7x</td><td style="text-align: right;">↖</td></tr> <tr><td>16:</td><td>10.9x</td><td style="text-align: right;">↖</td></tr> <tr><td>17:</td><td>10.1</td><td style="text-align: right;">↙</td></tr> <tr><td>18:</td><td>10.6x</td><td style="text-align: right;">↙</td></tr> <tr><td>19:</td><td>10.3</td><td style="text-align: right;">→</td></tr> <tr><td>20:</td><td>10.6x</td><td style="text-align: right;">↑</td></tr> </table>	11:	10.4	↙	12:	10.8x	↑	13:	10.7x	↙	14:	10.5x	↓	15:	10.7x	↖	16:	10.9x	↖	17:	10.1	↙	18:	10.6x	↙	19:	10.3	→	20:	10.6x	↑
11:	10.4	↙																													
12:	10.8x	↑																													
13:	10.7x	↙																													
14:	10.5x	↓																													
15:	10.7x	↖																													
16:	10.9x	↖																													
17:	10.1	↙																													
18:	10.6x	↙																													
19:	10.3	→																													
20:	10.6x	↑																													
<table style="width:100%; border-collapse: collapse;"> <tr> <td style="width:80%;">Serie</td> <td style="text-align: right;">100.0</td> </tr> <tr> <td>Total</td> <td style="text-align: right;">199.0</td> </tr> </table>		Serie	100.0	Total	199.0																										
Serie	100.0																														
Total	199.0																														

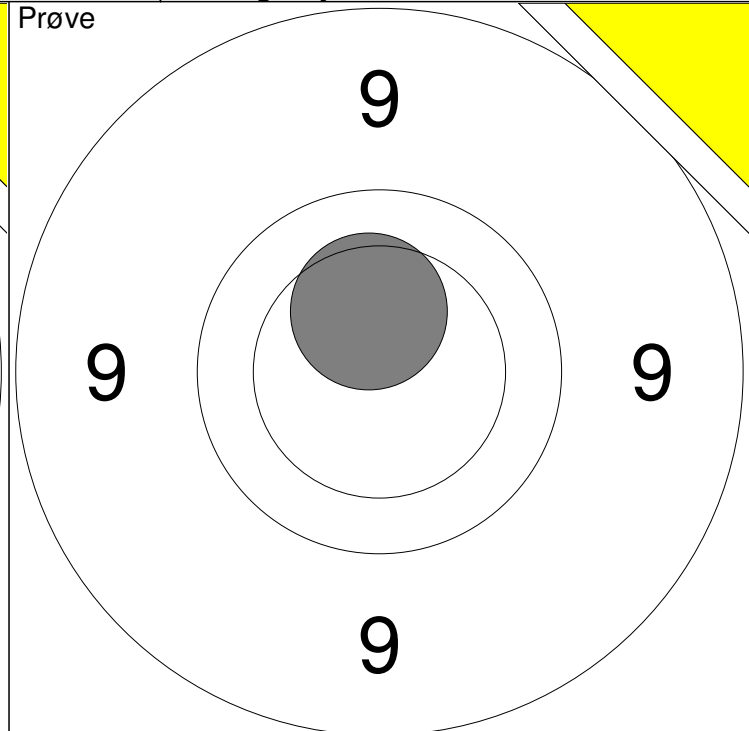
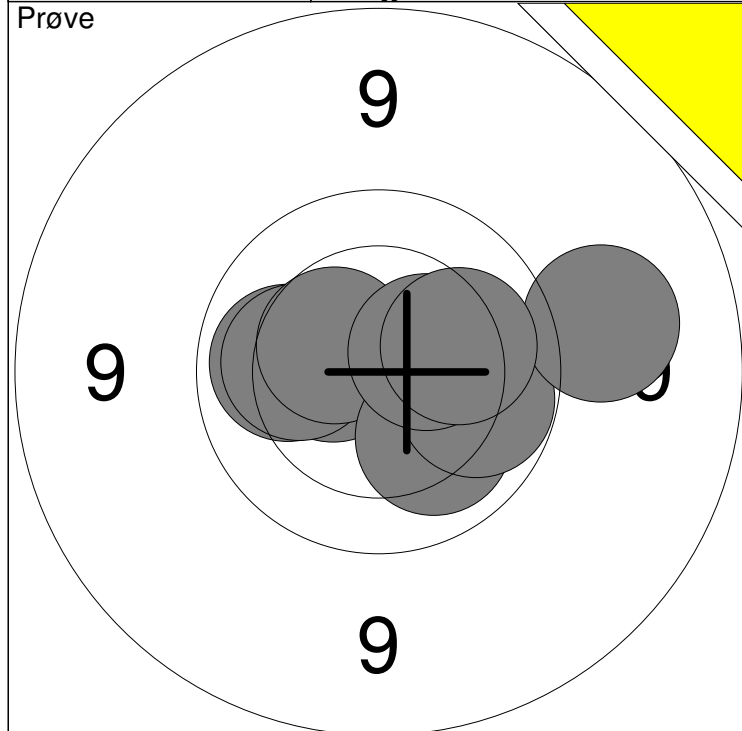

1: 10.5x ←	6: 10.1 ↘	Serie	99
2: 10.1 ←	7: 10.0 →		
3: 10.2 ←	8: 10.5 →	Total	0
4: 10.5 ↗	9: 9.3 →		
5: 10.2 ↘	10: 10.1 →		

11: 10.4 ↑		Serie	10
		Total	0

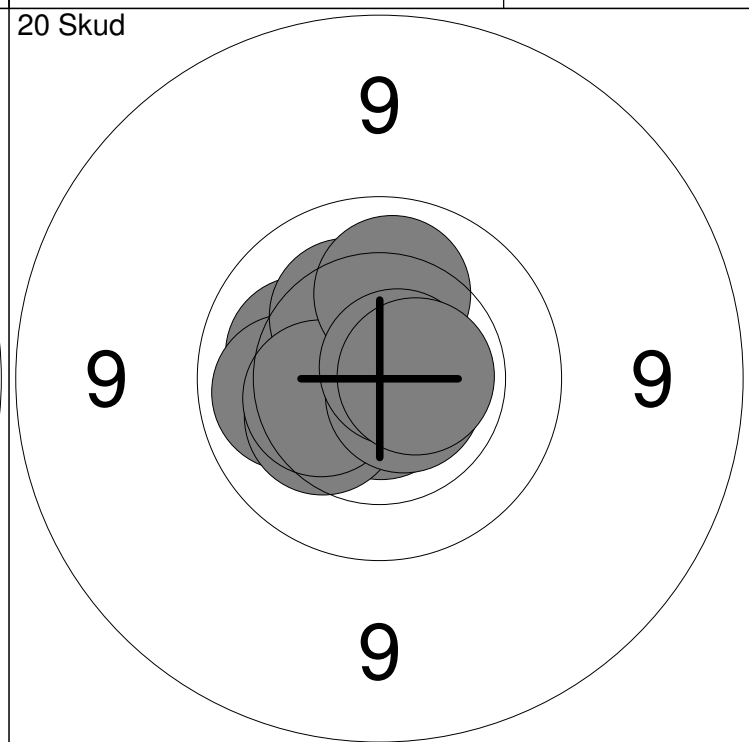
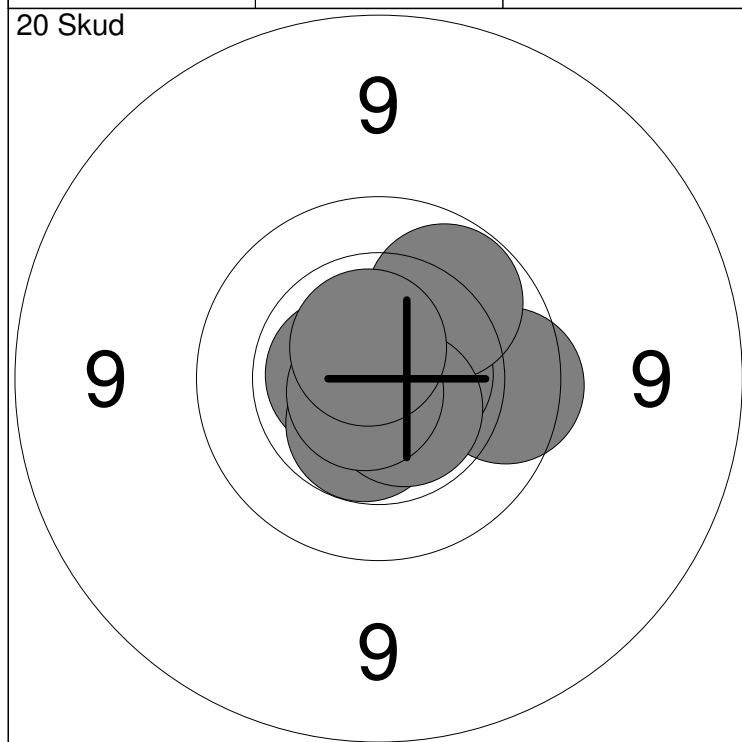

1: 10.1 →	6: 10.7x ↗	Serie	99
2: 10.6x ←	7: 10.0 ↗		
3: 10.5x ↓	8: 10.6x ↘	Total	99
4: 9.8 →	9: 10.8x ↙		
5: 10.6x →	10: 10.6x ↗		

11: 10.2 ←	16: 10.4 ←	Serie	100
12: 10.7x ↓	17: 10.7x ↘		
13: 10.1 ←	18: 10.1 ↑	Total	199
14: 10.3 ↗	19: 10.7x ↗		
15: 10.3 ↙	20: 10.6x →		